

OUTDOORDESIGN

RANGE BOOK

02/021





Atlas Concorde is a global specialist in premium porcelain and wall tiles for every style and application in residential, commercial and public architecture. Being global specialists means excellence in the level of design and technology in each type of surface, making it possible to always offer designers and end users the best solution for each application.

Atlas Concorde è specialista globale in superfici ceramiche d'eccellenza per ogni stile e applicazione nell'architettura residenziale, commerciale e pubblica. Essere specialisti globali significa eccellere per livello di design e tecnologia in ciascun tipo di superficie, così da offrire sempre ai progettisti e agli utilizzatori finali la soluzione migliore per ogni applicazione.

**COLOURED BODY
PORCELAIN TILES
GRES PORCELLANATO
COLORATO IN MASSA**
Grès cérame coloré
dans la masse
Durchgefärbtes
Feinsteinzeug
Gres porcelánico
coloreado en masa
Керамический гранит
окрашенный в массе

OUTDOOR DESIGN

RANGE BOOK

02/021





INDEX LOOK

8	Aix	84	Arbor
12	Brave	86	Axi
16	Dolmen Pro	90	Etic Pro
20	Klif	94	Exence
24	Kone	98	Nash
28	Lims		
32	Marvel Stone		
36	Norde		
40	Seastone		
42	Sunrock		
44	Trust		
48	Block	100	Blaze
52	Diesis		
56	Kava		
		102	Marvel Pro
60	Arkshade		
62	Boost		
66	Boost Pro		
70	Dwell		
72	Prism		
76	Raw		
80	Flux		

OUTDOOR RANGE

OUTDOOR PAVING ± 20 mm - ± 30 mm

STONELOOK

Lims Ivory Pag. 28	Diesis Avorio Pag. 52	Sunrock Jerusalem Ivory Pag. 42	Norde Magnesio Pag. 36	Block Bianco Pag. 48	Trust Ivory Pag. 44
Sunrock Bourgogne Sand Pag. 42	Lims Desert Pag. 28	Norde Oro Pag. 36	Lims Grey Pag. 28	Norde Platino Pag. 36	Aix Cendre Pag. 8
Brave Gypsum Pag. 12	Kava Ivory Pag. 56	Dolmen Pro Cenere Pag. 16	Klif Silver Pag. 20	Brave Pearl Pag. 12	Kone Pearl Pag. 24
Block Grigio Pag. 49	Brave Earth Pag. 12	Kone Grey Pag. 24	Brave Grey Pag. 12	Seastone Gray Pag. 40	Trust Titanium ± 20 mm ± 30 mm Pag. 44
Raw White Pag. 76	Dwell Off White Pag. 70	Flux Bone Pag. 80	Dwell Pearl Pag. 52	Raw Pearl Pag. 76	Boost White Pag. 62
Boost Grey Pag. 62	Boost Pro Taupe Pag. 66	Boost Smoke Pag. 62	Dwell Smoke Pag. 70	Boost Pro Tobacco Pag. 66	Boost Tarmac Pag. 62
Axi White Pine Pag. 86	Axi Golden Oak Pag. 86	Exence Almond Pag. 94	Etic Pro Rovere Venice Pag. 90	Exence Amber Pag. 94	Axi Brown Chestnut Pag. 86

CONCRETELOOK

Aix Blanc Pag. 8	Sunrock Rapolano Beige Pag. 42	Lims Beige Pag. 28	Diesis Beige Pag. 52	Aix Beige Pag. 8	Trust Gold ± 20 mm ± 30 mm Pag. 44
Seastone Greige Pag. 40	Norde Piombo Pag. 36	Diesis Greige Pag. 52	Dolmen Pro Mix Pag. 16	Block Beige Pag. 48	Dolmen Pro Rosso Pag. 16
Trust Silver ± 20 mm ± 30 mm Pag. 44	Kava Silver Pag. 56	Klif Grey Pag. 20	Dolmen Pro Grigio Pag. 16	Kava Grey Pag. 56	Marvel Stone Cardoso Elegant Pag. 30
Marvel Stone Basaltina Volcano Pag. 30	Aix Fumée Pag. 8	Brave Coke Pag. 12	Seastone Black Pag. 40	Klif Dark Pag. 20	
Boost Pro Cream Pag. 66	Raw Sand Pag. 76	Boost Pro Clay Pag. 66	Flux Concrete Pag. 80	Raw Mud Pag. 76	Dwell Gray Pag. 70
Flux Coke Pag. 80		Prism Cord Pag. 72	Prism Cloud Pag. 72	Prism Fog Pag. 72	Prism Suede Pag. 72
Etic Pro Noce Hickory Pag. 90	Axi Grey Timber Pag. 86			Blaze Corten Pag. 100	

RESINLOOK

METALLOOK

OUTDOOR RANGE

TEXTURED / GRIP ± 9 mm - 9,5 mm

STONELOOK

Kone White Pag. 26	Lims Ivory Pag. 30	Klif White Pag. 24	Brave Gypsum Pag. 12	Trust Moon Pag. 46	Norde Magnesio Pag. 38
Norde Oro Pag. 38	Lims Grey Pag. 30	Diesis Beige ± 8 mm Pag. 54	Aix Beige Pag. 10	Diesis Greige ± 8 mm Pag. 54	Trust Gold Pag. 46
Block Beige ± 8 mm $\pm 8,6$ mm Pag. 50	Dolmen Pro Rosso Pag. 18	Trust Copper Pag. 46	Kone Silver Pag. 26	Marvel Stone Clauzetto White Pag. 34	Kava Ivory ± 8 mm ± 9 mm Pag. 58
Klif Grey Pag. 22	Dolmen Pro Grigio Pag. 18	Kava Grey ± 8 mm ± 9 mm Pag. 58	Marvel Stone Cardoso Elegant Pag. 34	Block Grigio ± 8 mm $\pm 8,6$ mm Pag. 50	Brave Earth Pag. 12
Brave Coke Pag. 12	Klif Dark Pag. 22	CONCRETELOOK	Boost Pro Ivory Pag. 68	Arkshade White Pag. 60	Raw White Pag. 78
Flux Sand ± 8 mm Pag. 82	Arkshade Dove Pag. 60		Flux Concrete ± 8 mm Pag. 82	Boost Pro Clay Pag. 68	Raw Mud Pag. 78
Boost Tarmac Pag. 64	Flux Coke ± 8 mm Pag. 82	RESINLOOK	Prism Cord Pag. 74	Prism Cloud Pag. 74	Prism Fog Pag. 74
Exence Almond Pag. 96	Arbor Natural Pag. 84		Etic Pro Rovere Venice Pag. 92	Exence Amber Pag. 96	Axi Brown Chestnut $\pm 9,5$ mm Pag. 88
Nash Greige Pag. 98	Arbor Grey Pag. 84	Nash Gray Wood Pag. 98	Axi Grey Timber $\pm 9,5$ mm Pag. 88	Nash Dark Oak Pag. 98	
Marvel Pro Crema Delicato Pag. 102	Marvel Pro Statuario Select Pag. 102	Marvel Pro Grey Fleury Pag. 102			

MARBLELOOK

Block Bianco ± 8 mm $\pm 8,6$ mm Pag. 50	Trust Ivory Pag. 46	Diesis Avorio ± 8 mm Pag. 54	Aix Blanc Pag. 10	Kone Beige Pag. 26	Lims Beige Pag. 30
Lims Desert Pag. 30	Marvel Stone Desert Beige Pag. 34	Norde Platino Pag. 38	Aix Cendre Pag. 10	Norde Piombo Pag. 38	Dolmen Pro Mix Pag. 18
Dolmen Pro Cenere Pag. 18	Klif Silver Pag. 22	Brave Pearl Pag. 12	Kone Pearl Pag. 26	Trust Silver Pag. 46	Kava Silver ± 8 mm ± 9 mm Pag. 58
Kone Grey Pag. 26	Brave Grey Pag. 12	Trust Titanium Pag. 46	Marvel Stone Basaltina Volcano Pag. 34	Block Fumo ± 8 mm $\pm 8,6$ mm Pag. 50	Aix Fumée Pag. 10
Flux Bone ± 8 mm Pag. 82	Arkshade Clay Pag. 60	Raw Pearl Pag. 78	Boost White Pag. 64	Boost Pro Cream Pag. 68	Raw Sand Pag. 78
Boost Pearl Pag. 64	Boost Grey Pag. 64	Boost Pro Taupe Pag. 68	Arkshade Lead Pag. 60	Boost Smoke Pag. 64	Boost Pro Tobacco Pag. 68
Prism Suede Pag. 74	WOODLOOK	Axi White Pine $\pm 9,5$ mm Pag. 88	Arbor Almond Pag. 84	Exence Vanilla Pag. 96	Axi Golden Oak $\pm 9,5$ mm Pag. 88
Etic Pro Noce Hickory Pag. 92		Axi Dark Oak $\pm 9,5$ mm Pag. 88	Arbor Tobacco Pag. 84	Nash Light Brown Pag. 98	Nash White Wood Pag. 98
	METALLOOK	Blaze Aluminium Pag. 100	Blaze Iron Pag. 100	Blaze Corten Pag. 100	

AIX

COLOURED BODY PORCELAIN TILES / GRES PORCELLANATO COLORATO IN MASSA

Grès cérame coloré dans la masse . Durchgefärbtes Feinsteinzeug . Gres porcelánico coloreado en masa . Керамический гранит окрашенный в массе



OUTDOOR PAVING / PAVIMENTI DA ESTERNO

Sols d'extérieur . Bodenbeläge für Außenbereiche . Pavimentos para exteriores . Уличная плитка

20 mm

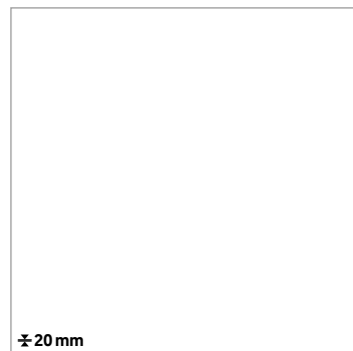

120x120 cm



60x90 cm



60x60 cm

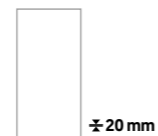

22,5x45,4 cm



22,5x22,5 cm

Rectified monocaliber . Rettificato monocalibro . Rectifié monocalibre . Rektifiziert Monokalibriert . Rectificado monocalibre . Одном калибре

120x120 cm 47¹/₈"x47¹/₈" 20 mm Blanc / Beige / Cendre / Fumée

60x90 cm 23⁵/₈"x35⁵/₈" 20 mm Blanc / Beige / Cendre / Fumée

60x60 cm 23⁵/₈"x23⁵/₈" 20 mm Beige / Cendre

Not rectified . Non rettificato . Non rectifié . Nicht Rektifiziert . No Rectificado . Неретифицированные

22,5x45,4 cm 8⁷/₈"x17³/₄" 20 mm Beige / Cendre

22,5x22,5 cm 8⁷/₈"x8⁷/₈" 20 mm Beige / Cendre



Blanc



Beige



Cendre

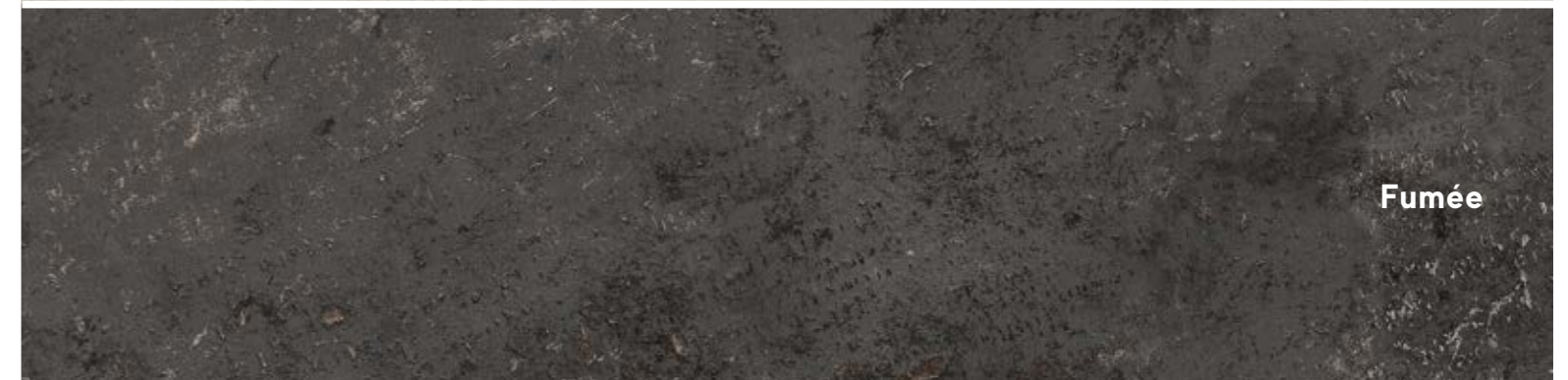

Fumée

AIX

COLOURED BODY PORCELAIN TILES / GRES PORCELLANATO COLORATO IN MASSA

Grès cérame coloré dans la masse . Durchgefärbtes Feinsteinzeug . Gres porcelánico coloreado en masa . Керамический гранит окрашенный в массе



R11
A+B+C

HEAVY
TRAFFIC

V3
MODERATE
VARIATION

GRIP SURFACE / SUPERFICIE GRIP

Surface grip . Grip oberfläche . Superficie Grip . Grip поверхность

9 mm



37,5x75 cm

Rectified monocaliber . Rettificato monocalibro . Rectifié monocalibre . Rektifiziert Monokalibriert . Rectificado monocalibre . Одном калибре

37,5x75 cm 14³/₈"x29¹/₂" ± 9 mm Blanc / Beige / Cendre / Fumée

TEXTURED SURFACE / SUPERFICIE STRUTTURATA

Surface structuré . Strukturiert oberfläche . Superficie estructurado . Структурная поверхность

9 mm

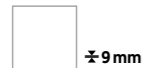

22,5x45,4 cm 22,5x22,5 cm

Not rectified monocaliber . Non rettificato monocalibro . Non rectifié monocalibre . Nicht Rektifiziert Monokalibriert . No Rectificado monocalibre . Неретифицированные

22,5x45,4 cm 8⁷/₈"x17³/₄" ± 9 mm Beige / Cendre

22,5x22,5 cm 8⁷/₈"x8⁷/₈" ± 9 mm Beige / Cendre

DECORS



Aix Brick Tumbled 37x37 cm 14⁵/₈"x14⁵/₈"
Blanc / Beige / Cendre / Fumée

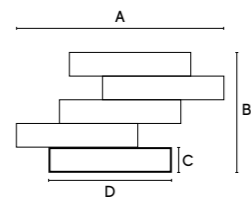

A: 62,7 cm - 24³/₈"
B: 36,7 cm - 14³/₈"
C: 7,15 cm - 2⁷/₁₆"
D: 36,65 cm - 14³/₈"



Blanc



Beige



Cendre



Fumée

BRAVE

COLOURED BODY PORCELAIN TILES / GRES PORCELLANATO COLORATO IN MASSA

Grès cérame coloré dans la masse . Durchgefärbtes Feinsteinzeug . Gres porcelánico coloreado en masa . Керамический гранит окрашенный в массе



OUTDOOR PAVING / PAVIMENTI DA ESTERNO

Sols d'extérieur . Bodenbeläge für Außenbereiche . Pavimentos para exteriores . Уличная плитка

20 mm

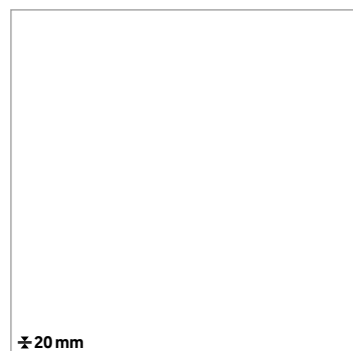

120x120 cm

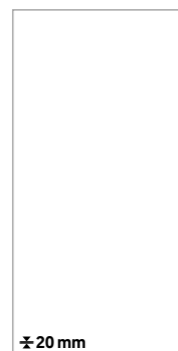

60x120 cm



45x90 cm



60x60 cm



30x60 cm

Rectified monocaliber . Rettificato monocalibro . Rectifié monocalibre . Rektifiziert Monokalibriert . Rectificado monocalibre . Одном калибре

120x120 cm 47¹/₄"x47¹/₄" 20 mm Grey / Coke

60x120 cm 23⁵/₈"x47¹/₄" 20 mm Gypsum / Pearl / Grey / Earth / Coke

45x90 cm 17³/₄"x35³/₈" 20 mm Gypsum / Pearl / Grey / Earth / Coke

60x60 cm 23⁵/₈"x23⁵/₈" 20 mm Gypsum / Pearl / Grey / Earth / Coke

30x60 cm 11³/₄"x23⁵/₈" 20 mm Gypsum / Pearl / Grey / Earth / Coke



Gypsum



Pearl



Grey



Earth



Coke

BRAVE

COLOURED BODY PORCELAIN TILES / GRES PORCELLANATO COLORATO IN MASSA

Grès cérame coloré dans la masse . Durchgefärbtes Feinsteinzeug . Gres porcelánico coloreado en masa . Керамический гранит окрашенный в массе



V2
SLIGHT
VARIATION

GRIP SURFACE / SUPERFICIE GRIP

Surface grip . Grip oberfläche . Superficie Grip . Grip поверхность

9 mm



30x60 cm

Rectified monocaliber . Rettificato monocalibro . Rectifié monocalibre . Rektifiziert Monokalibriert . Rectificado monocalibre . Одном калибре

30x60 cm 11³/₄"x23⁵/₈" \pm 9 mm Gypsum / Pearl / Grey / Earth / Coke

DECORS



Brave Listello 8x60 cm 3¹/₈"x23⁵/₈"

Gypsum / Pearl / Grey / Earth / Coke



Gypsum



Pearl



Grey



Earth



Coke

DOLMEN PRO

COLOURED BODY PORCELAIN TILES / GRES PORCELLANATO COLORATO IN MASSA

Grès cérame coloré dans la masse . Durchgefärbtes Feinsteinzeug . Gres porcelánico coloreado en masa . Керамический гранит окрашенный в массе



R11
A+B+C



H
HEAVY
TRAFFIC



V2
SLIGHT
VARIATION

Cenere / Rosso / Grigio



V4
SUBSTANTIAL
VARIATION

Mix

OUTDOOR PAVING / PAVIMENTI DA ESTERNO

Sols d'extérieur . Bodenbeläge für Außenbereiche . Pavimentos para exteriores . Уличная плитка

20 mm

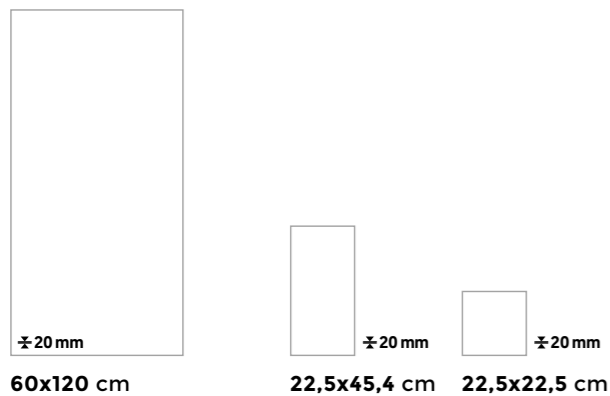

Rectified monocaliber . Rettificato monocalibro . Rectifié monocalibre . Rektifiziert Monokalibriert . Rectificado monocalibre . Одном калибре

60x120 cm 23⁵/₈"x47¹/₄" ± 20 mm Cenere / Grigio / Rosso

Not rectified . Non rettificato . Non rectifié . Nicht Rektifiziert . No Rectificado . Неретифицированные

22,5x45,4 cm 8⁷/₈"x17³/₄" ± 20 mm Rosso / Mix

22,5x22,5 cm 8⁷/₈"x8⁷/₈" ± 20 mm Rosso / Mix



DOLMEN PRO

COLOURED BODY PORCELAIN TILES / GRES PORCELLANATO COLORATO IN MASSA

Grès cérame coloré dans la masse . Durchgefärbtes Feinsteinzeug . Gres porcelánico coloreado en masa . Керамический гранит окрашенный в массе



R11
A+B+C

HEAVY
TRAFFIC

V2
SLIGHT
VARIATION
Cenere / Rosso / Grigio

Mix

V4
SUBSTANTIAL
VARIATION

GRIP SURFACE / SUPERFICIE GRIP

Surface grip . Grip oberfläche . Superficie Grip . Grip поверхность

9 mm



±9mm

37,5x75 cm

Rectified monocaliber . Rettificato monocalibro . Rectifié monocalibre . Rektifiziert Monokalibriert . Rectificado monocalibre . Одном калибре

37,5x75 cm 14³/₄"x29¹/₂" ± 9 mm Cenere / Grigio / Rosso / Mix

TEXTURED SURFACE / SUPERFICIE STRUTTURATA

Surface structuré . Strukturiert oberfläche . Superficie estructurado . Структурная поверхность

9 mm



±9mm



±9mm

22,5x45,3 cm 22,5x22,5 cm

Not rectified monocaliber . Non rettificato monocalibro . Non rectifié monocalibre . Nicht Rektifiziert Monokalibriert . No Rectificado monocalibre . Неретифицированные

22,5x45,3 cm 8⁷/₈"x17³/₄" ± 9 mm Cenere / Grigio / Rosso / Mix

22,5x22,5 cm 8⁷/₈"x8⁷/₈" ± 9 mm Cenere / Grigio / Rosso / Mix

DECORS

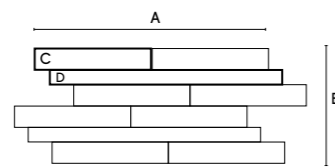

A: 74,8 cm - 29¹/₂"
B: 37,4 cm - 14³/₄"
C: 7x37,3 cm - 2³/₄"x14³/₄"
D: 4,2x74,8 cm - 1¹/₈"x29¹/₂"

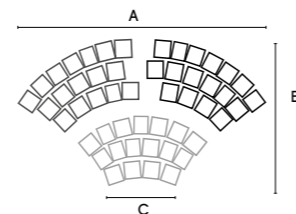
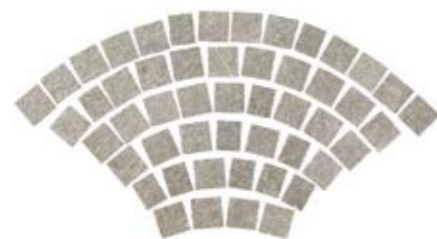

A: 102,8 cm - 40¹/₂"
B: 53,2 cm - 20⁷/₈"
C: 30,5 cm - 12"

Dolmen Pro Brick 37,5x75 cm 14³/₄"x29¹/₂"

Cenere / Grigio / Rosso / Mix

Dolmen Pro Coda di Pavone* 53,2x102,8 cm 20³/₄"x29¹/₂"

Cenere / Grigio / Rosso / Mix / Cenere-Rosso

* Tumbled / Burattato / Tamisé / Genarbt / Tamboreado / Выщербленный



Cenere



Grigio

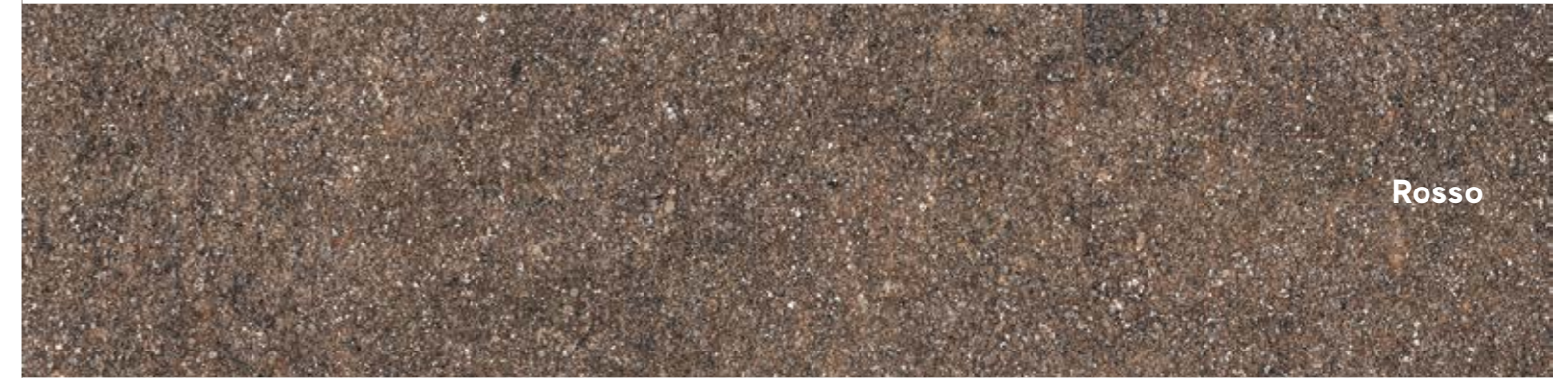

Rosso



Mix

KLIF

COLOURED BODY PORCELAIN TILES / GRES PORCELLANATO COLORATO IN MASSA

Grès cérame coloré dans la masse . Durchgefärbtes Feinsteinzeug . Gres porcelánico coloreado en masa . Керамический гранит окрашенный в массе



R11
A+B+C

HEAVY
TRAFFIC

V2
SLIGHT
VARIATION

OUTDOOR PAVING / PAVIMENTI DA ESTERNO

Sols d'extérieur . Bodenbeläge für Außenbereiche . Pavimentos para exteriores . Уличная плитка

20 mm



±20 mm

90x90 cm



±20 mm

45x90 cm

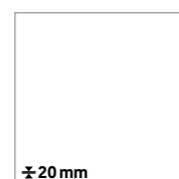

±20 mm

60x60 cm

Rectified monocaliber . Rettificato monocalibro . Rectifié monocalibre . Rektifiziert Monokalibriert . Rectificado monocalibre . Одном калибре

90x90 cm 35³/₈"x35³/₈" ± 20 mm Silver / Grey / Dark

45x90 cm 17³/₄"x35³/₈" ± 20 mm Silver / Grey / Dark

60x60 cm 23⁵/₈"x23⁵/₈" ± 20 mm Silver / Grey / Dark



Silver

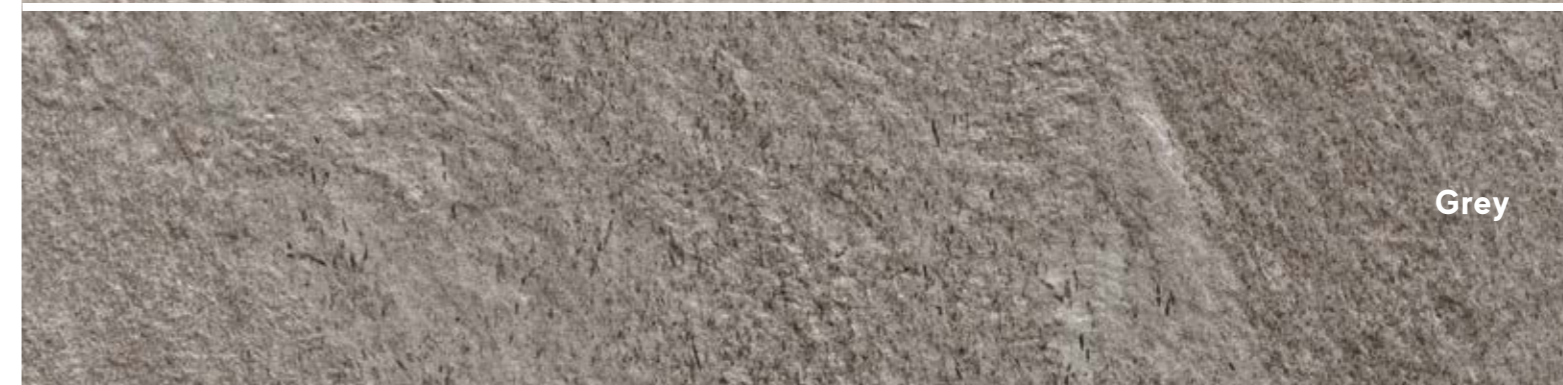

Grey



Dark

KLIF

COLOURED BODY PORCELAIN TILES / GRES PORCELLANATO COLORATO IN MASSA

Grès cérame coloré dans la masse . Durchgefärbtes Feinsteinzeug . Gres porcelánico coloreado en masa . Керамический гранит окрашенный в массе



GRIP SURFACE / SUPERFICIE GRIP

Surface grip . Grip oberfläche . Superficie Grip . Grip поверхность

9 mm



37,5x75 cm

Rectified monocaliber . Rettificato monocalibro . Rectifié monocalibre . Rektifiziert Monokalibriert . Rectificado monocalibre . Одном калибре

37,5x75 cm 14³/₄"x29¹/₂" \pm 9 mm White / Silver / Grey / Dark

DECORS

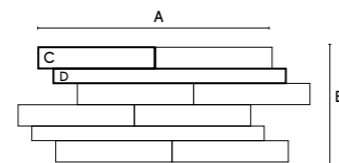

A: 74,8 cm - 29¹/₂"
 B: 37,4 cm - 14³/₄"
 C: 7x37,3 cm - 2³/₄"x14³/₄"
 D: 4,2x74,8 cm - 1¹/₂"x29¹/₂"

Klif Brick 37,5x75 cm 14³/₄"x29¹/₂"
 White / Silver / Grey / Dark



White



Silver

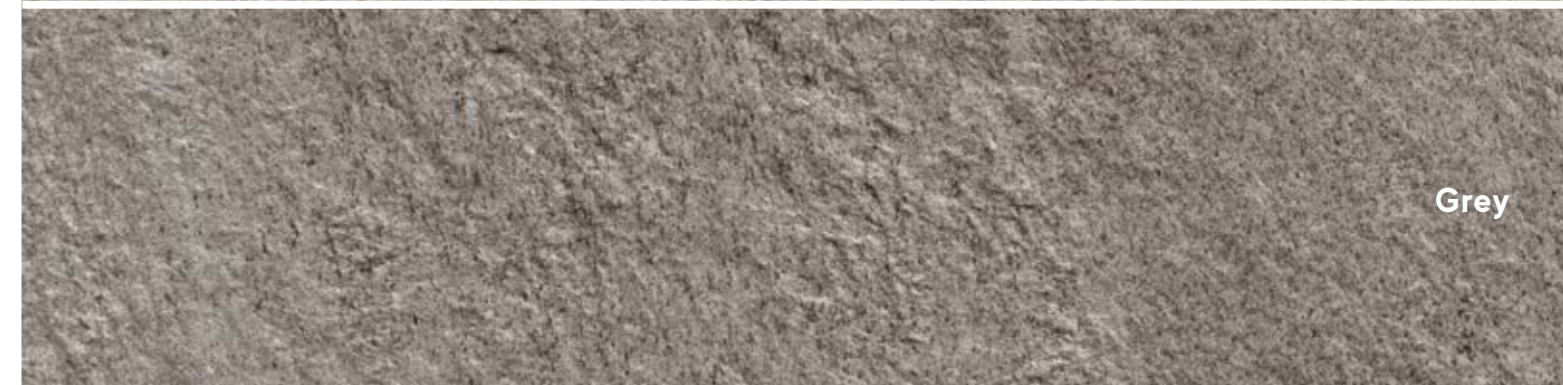

Grey



Dark

KONE

COLOURED BODY PORCELAIN TILES / GRES PORCELLANATO COLORATO IN MASSA

Grès cérame coloré dans la masse . Durchgefärbtes Feinsteinzeug . Gres porcelánico coloreado en masa . Керамический гранит окрашенный в массе



OUTDOOR PAVING / PAVIMENTI DA ESTERNO

Sols d'extérieur . Bodenbeläge für Außenbereiche . Pavimentos para exteriores . Уличная плитка

 20 mm



Pearl



Grey

STONE LOOK



 20 mm

60x60 cm

Rectified monocaliber . Rettificato monocalibro . Rectifié monocalibre . Rektifiziert Monokalibriert . Rectificado monocalibre . Одном калибре

60x60 cm $23\frac{5}{8} \times 23\frac{5}{8}$ "  20 mm Pearl / Grey

KONE

COLOURED BODY PORCELAIN TILES / GRES PORCELLANATO COLORATO IN MASSA

Grès cérame coloré dans la masse . Durchgefärbtes Feinsteinzeug . Gres porcelánico coloreado en masa . Керамический гранит окрашенный в массе



GRIP SURFACE / SUPERFICIE GRIP

Surface grip . Grip oberfläche . Superficie Grip . Grip поверхность

9 mm



30x60 cm

Rectified monocaliber . Rettificato monocalibro . Rectifié monocalibre . Rektifiziert Monokalibriert . Rectificado monocalibre . Одном калибре

30x60 cm 11³/₄"x23⁵/₈" \pm 9 mm Beige / Pearl / Silver / Grey

DECORS



Kone Brick 30x60 cm 11³/₄"x23⁵/₈"
White / Beige / Pearl / Silver / Grey

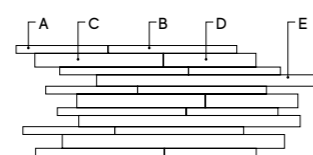

A: 2,1x24,8 cm - 3¹/₄"x9¹/₄"
B: 2,1x34,5 cm - 3¹/₄"x13⁵/₈"
C: 3,3x34,5 cm - 1¹/₄"x13⁵/₈"
D: 3,3x24,8 cm - 1¹/₄"x9¹/₄"
E: 2,5x60 cm - 1"x23⁵/₈"



Industrial 3D 31,5x45 cm 12³/₈"x17³/₄"
Warm / Cold



Kone Listello 8x60 cm 3¹/₈"x23⁵/₈"
White / Beige / Pearl / Silver / Grey



White



Beige



Pearl



Silver



Grey

LIMS

COLOURED BODY PORCELAIN TILES / GRES PORCELLANATO COLORATO IN MASSA

Grès cérame coloré dans la masse . Durchgefärbtes Feinsteinzeug . Gres porcelánico coloreado en masa . Керамический гранит окрашенный в массе



OUTDOOR PAVING / PAVIMENTI DA ESTERNO

Sols d'extérieur . Bodenbeläge für Außenbereiche . Pavimentos para exteriores . Уличная плитка

20 mm



20 mm

60x120 cm



20 mm

60x60 cm

Rectified monocaliber . Rettificato monocalibro . Rectifié monocalibre . Rektifiziert Monokalibriert . Rectificado monocalibre . Одном калибре

60x120 cm 23⁵/₈"x47¹/₄" 20 mm Ivory / Beige / Grey / Desert

60x60 cm 23⁵/₈"x23⁵/₈" 20 mm Ivory / Beige / Grey / Desert



Ivory



Beige



Grey



Desert

LIMS

COLOURED BODY PORCELAIN TILES / GRES PORCELLANATO COLORATO IN MASSA

Grès cérame coloré dans la masse . Durchgefärbtes Feinsteinzeug . Gres porcelánico coloreado en masa . Керамический гранит окрашенный в массе

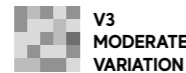

R11
A+B+C

H
HEAVY
TRAFFIC

V3
MODERATE
VARIATION

GRIP SURFACE / SUPERFICIE GRIP

Surface grip . Grip oberfläche . Superficie Grip . Grip поверхность

9 mm



± 9 mm

37,5x75 cm

Rectified monocaliber . Rettificato monocalibro . Rectifié monocalibre . Rektifiziert Monokalibriert . Rectificado monocalibre . Одном калибре

37,5x75 cm 14³/₄"x29¹/₂" ± 9 mm Ivory / Beige / Grey / Desert

DECORS



A: 75 cm - 29¹/₂"
B: 37,5 cm - 14³/₄"
C: 6,9 x 49,1 cm - 2³/₄"x19¹/₄"
D: 4,4 x 75 cm - 1¹/₄"x29¹/₂"

Lims Brick 37,5x75 cm 14³/₄"x29¹/₂"

Ivory / Beige / Grey / Desert

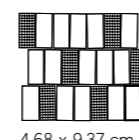

4,68 x 9,37 cm
1¹/₄"x3³/₄"

Lims Mosaico Spritz 29x32,3 cm 12³/₈"x17³/₄"

Ivory / Beige / Grey / Desert

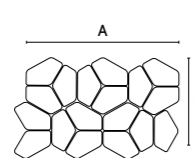

A: 41,6 cm - 12¹/₄"
B: 24 cm - 9¹/₂"

Lims Mosaico Gemini 41,6x24 cm 12¹/₄"x9¹/₂"

Ivory / Beige / Grey / Desert

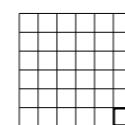

4,8 x 4,8 cm
1¹/₈"x1¹/₈"

Lims Mosaico Tumbled 30x30 cm 11³/₄"x11³/₄"

Ivory / Beige / Grey / Desert



Ivory



Beige



Grey



Desert

MARVEL STONE

COLOURED BODY PORCELAIN TILES / GRES PORCELLANATO COLORATO IN MASSA

Grès cérame coloré dans la masse . Durchgefärbtes Feinsteinzeug . Gres porcelánico coloreado en masa . Керамический гранит окрашенный в массе



OUTDOOR PAVING / PAVIMENTI DA ESTERNO

Sols d'extérieur . Bodenbeläge für Außenbereiche . Pavimentos para exteriores . Уличная плитка

 20 mm



 20 mm

60x120 cm

Rectified monocaliber . Rettificato monocalibro . Rectifié monocalibre . Rektifiziert Monokalibriert . Rectificado monocalibre . Одном калибре

60x120 cm $23\frac{5}{8} \times 47\frac{1}{4}$ "  20 mm Cardoso Elegant / Basaltina Volcano

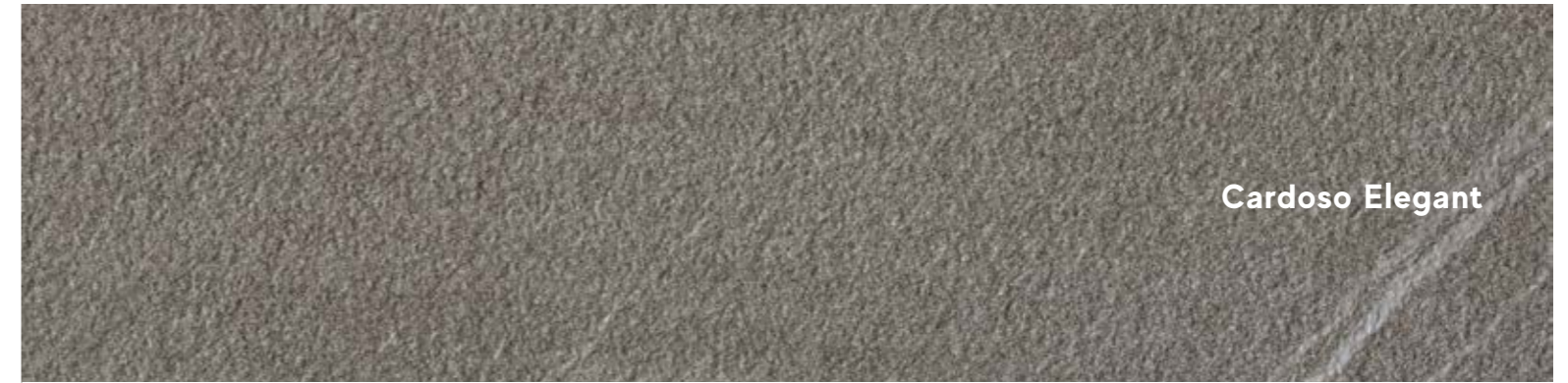

Cardoso Elegant



Basaltina Volcano

MARVEL STONE

COLOURED BODY PORCELAIN TILES / GRES PORCELLANATO COLORATO IN MASSA

Grès cérame coloré dans la masse . Durchgefärbtes Feinsteinzeug . Gres porcelánico coloreado en masa . Керамический гранит окрашенный в массе



R11
A+B+C

H
HEAVY
TRAFFIC

V2
SLIGHT
VARIATION

TEXTURED SURFACE / SUPERFICIE STRUTTURATA

Surface structuré . Strukturiert oberfläche . Superficie estructurado . Структурная поверхность

9 mm



30x60 cm

Rectified monocaliber . Rettificato monocalibro . Rectifié monocalibre . Rektifiziert Monokalibriert . Rectificado monocalibre . Одном калибре

30x60 cm $11\frac{3}{4}'' \times 23\frac{5}{8}''$ 9 mm Desert Beige / Clauzetto White / Cardoso Elegant / Basaltina Volcano

DECORS



Marvel Stone Brick 30x60 cm $11\frac{3}{4}'' \times 23\frac{5}{8}''$

Desert Beige / Clauzetto White
Cardoso Elegant / Basaltina Volcano

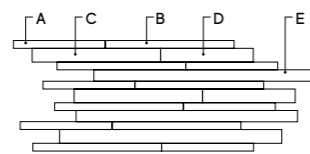

A: 2,1x24,8 cm - $\frac{3}{4}'' \times 9\frac{3}{4}''$
B: 2,1x34,5 cm - $\frac{3}{4}'' \times 13\frac{5}{8}''$
C: 3,3x34,5 cm - $1\frac{3}{4}'' \times 13\frac{5}{8}''$
D: 3,3x24,8 cm - $1\frac{3}{4}'' \times 9\frac{3}{4}''$
E: 2,5x60 cm - $1'' \times 23\frac{5}{8}''$



Marvel Stone Mosaico Bacchetta
30x30 cm $11\frac{3}{4}'' \times 11\frac{3}{4}''$

Desert Beige / Clauzetto White
Cardoso Elegant / Basaltina Volcano

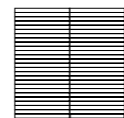

1x15 cm - $\frac{3}{8}'' \times 5\frac{7}{8}''$



Marvel Stone Listello 7x60 cm $2\frac{3}{4}'' \times 23\frac{5}{8}''$

Desert Beige / Clauzetto White / Cardoso Elegant / Basaltina Volcano



Desert Beige



Clauzetto White



Cardoso Elegant



Basaltina Volcano

NORDE

COLOURED BODY PORCELAIN TILES / GRES PORCELLANATO COLORATO IN MASSA

Grès cérame coloré dans la masse . Durchgefärbtes Feinsteinzeug . Gres porcelánico coloreado en masa . Керамический гранит окрашенный в массе

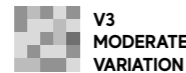

OUTDOOR PAVING / PAVIMENTI DA ESTERNO

Sols d'extérieur . Bodenbeläge für Außenbereiche . Pavimentos para exteriores . Уличная плитка

± 20 mm



60x120 cm



60x90 cm

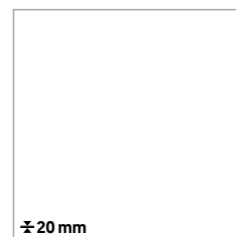

80x80 cm

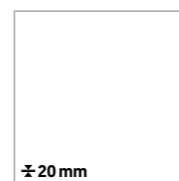

60x60 cm

Rectified monocaliber . Rettificato monocalibro . Rectifié monocalibre . Rektifiziert Monokalibriert . Rectificado monocalibre . Одном калибре

60x120 cm 23⁵/₈"x47¹/₄" ± 20 mm Magnesio / Oro / Platino / Piombo

60x90 cm 23⁵/₈"x35³/₈" ± 20 mm Magnesio / Oro / Platino / Piombo

80x80 cm 31¹/₂"x31¹/₂" ± 20 mm Magnesio / Oro / Platino / Piombo

60x60 cm 23⁵/₈"x23⁵/₈" ± 20 mm Magnesio / Oro / Platino / Piombo

DECORS



Norde Path A+B ± 20 mm
54x54 cm 21¹/₄"x21¹/₄"

Magnesio / Oro / Platino / Piombo



Norde Path C ± 20 mm
55x109 cm 21⁵/₈"x42⁷/₈"

Magnesio / Oro / Platino / Piombo

We recommend "dry" installation on gravel and/or grass . Si consiglia posa "a secco" su ghiaia e/o erba . Pose « à sec » sur gravillons et/ou herbe conseillée . Es wird eine Trockenverlegung auf Kies bzw. Rasen empfohlen . Se recomienda colocación «en seco» sobre grava o hierba . Рекомендуется «сухая» укладка на гравий и/или траву.



Magnesio



Oro



Platino



Piombo

NORDE

COLOURED BODY PORCELAIN TILES / GRES PORCELLANATO COLORATO IN MASSA

Grès cérame coloré dans la masse . Durchgefärbtes Feinsteinzeug . Gres porcelánico coloreado en masa . Керамический гранит окрашенный в массе



GRIP SURFACE / SUPERFICIE GRIP

Surface grip . Grip oberfläche . Superficie Grip . Grip поверхность

9 mm

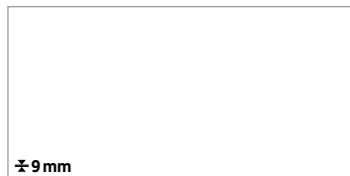

60x120 cm

Rectified monocaliber . Rettificato monocalibro . Rectifié monocalibre . Rektifiziert Monokalibriert . Rectificado monocalibre . Одном калибре

60x120 cm $23\frac{5}{8} \times 47\frac{1}{4}$ 9 mm Magnesio / Oro / Platino / Piombo

ROCCIA SURFACE / SUPERFICIE ROCCIA

Surface structuré . Strukturiert oberfläche . Superficie estructurado . Структурная поверхность

9 mm



30x60 cm

Not rectified monocaliber . Non rettificato monocalibro . Non rectifié monocalibre . Nicht Rektifiziert Monokalibriert . No Rectificado monocalibre . Неретифицированные

30x60 cm $11\frac{3}{4} \times 23\frac{5}{8}$ 9 mm Magnesio / Oro / Platino / Piombo

DECORS



Norde Composizione Palladiana Grip *

Magnesio / Oro / Platino / Piombo



Norde Brick 30x60 cm $11\frac{3}{4} \times 23\frac{5}{8}$ "

Magnesio / Oro / Platino / Piombo



Norde Brick Corten ** 27,8x39 cm $11 \times 15\frac{3}{8}$ "

Magnesio / Oro / Platino / Piombo

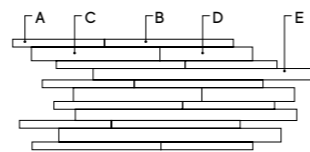

A: 2,1x24,8 cm - $\frac{3}{4} \times 9\frac{7}{8}$ "
 B: 2,1x34,5 cm - $\frac{3}{4} \times 13\frac{5}{8}$ "
 C: 3,3x34,5 cm - $1\frac{1}{4} \times 13\frac{5}{8}$ "
 D: 3,3x24,8 cm - $1\frac{1}{4} \times 9\frac{7}{8}$ "
 E: 2,5x60 cm - $1 \times 23\frac{5}{8}$ "

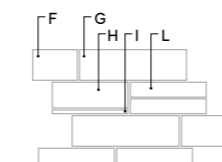

F: 7,82x11,42 cm - $3\frac{1}{8} \times 4\frac{1}{2}$ "
 G: 7,82x27,42 cm - $3\frac{1}{8} \times 10\frac{7}{8}$ "
 H: 1,0x19,42 cm - $\frac{3}{8} \times 7\frac{5}{8}$ "
 I: 6,64x19,42 cm - $2\frac{5}{8} \times 7\frac{5}{8}$ "
 L: 3,82x19,42 cm - $1\frac{5}{8} \times 7\frac{5}{8}$ "



Magnesio



Oro



Platino



Piombo

* Example of layout measuring about 1 m². Minimum order: 8 m². Variable tessera size and shape with tumbled edge. We recommend installation with a joint of no less than 10 mm . Esempio di posato corrispondente a circa 1 mq. Ordine minimo di 8 mq. Dimensione e forma delle tessere variabile con bordo burattato. Si consiglia posa con fuga non inferiore a 10mm . Exemple de produit posé correspondant à 1 mètre carré environ. Commande minimum: 8 mètres carrés. Dimensions et forme des tesselles variables avec bord tamisé. Pose conseillée avec un joint non inférieur à 10mm . Verlegebeispiel für circa 1 qm. Mindestbestellmenge 8 qm. Abmessung und Form der Steine sind unterschiedlich, aber alle weisen getrommelte Kanten auf. Für die Verlegung wird eine Fugenbreite von nicht weniger als 10 mm empfohlen . Ejemplo de colocación correspondiente aproximadamente a 1 m. Pedido mínimo de 8 m. Tamaño y forma variable de los mosaicos con borde bruñido. Se recomienda colocación con junta de no menos de 10 mm . Пример укладки, соответствующий примерно 1 кв.м. Минимальный объем заказа – 8 кв.м. Размер и форма чипса варьируются, чипсы имеют выщербленные края. Рекомендуется укладка с межплиточным швом не менее 10 мм.

** Blaze Corten Lappato tessera inserted randomly in four of the six sheets contained in each box . Tessera Blaze Corten Lappato inserita in modo casuale in quattro dei sei fogli contenuti in ogni scatola . Tesselles Blaze Corten Lappato posées de manière aléatoire sur quatre des six feuilles contenues dans chaque boîte . Die Blaze Corten Lappato Steine werden nach dem Zufallsprinzip auf vier der sechs in jedem Karton enthaltenen Folien verklebt . Mosaico Blaze Corten Lappato insertado al azar en cuatro de las seis hojas que contiene cada caja . Чипса Blaze Corten Lappato включена случайным образом в четыре из шести матриц, содержащихся в каждой коробке.

SEASTONE

COLOURED BODY PORCELAIN TILES / GRES PORCELLANATO COLORATO IN MASSA

Grès cérame coloré dans la masse . Durchgefärbtes Feinsteinzeug . Gres porcelánico coloreado en masa . Керамический гранит окрашенный в массе



OUTDOOR PAVING / PAVIMENTI DA ESTERNO

Sols d'extérieur . Bodenbeläge für Außenbereiche . Pavimentos para exteriores . Уличная плитка

 20 mm



\pm 20 mm

60x60 cm

Rectified monocaliber . Rettificato monocalibro . Rectifié monocalibre . Rektifiziert Monokalibriert . Rectificado monocalibre . Одном калибре

60x60 cm $23\frac{5}{8} \times 23\frac{5}{8}$ " \pm 20 mm Greige / Gray / Black



Greige



Gray



Black

SUNROCK

COLOURED BODY PORCELAIN TILES / GRES PORCELLANATO COLORATO IN MASSA

Grès cérame coloré dans la masse . Durchgefärbtes Feinsteinzeug . Gres porcelánico coloreado en masa . Керамический гранит окрашенный в массе



OUTDOOR PAVING / PAVIMENTI DA ESTERNO

Sols d'extérieur . Bodenbeläge für Außenbereiche . Pavimentos para exteriores . Уличная плитка

20 mm

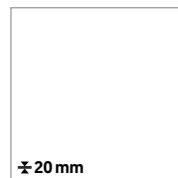

20 mm

60x60 cm

Rectified monocaliber . Rettificato monocalibro . Rectifié monocalibre . Rektifiziert Monokalibriert . Rectificado monocalibre . Одном калибре

60x60 cm 23⁵/₈"x23⁵/₈" 20 mm Jerusalem Ivory / Bourgogne Sand / Rapolano Beige



Jerusalem Ivory



Bourgogne Sand



Rapolano Beige

TRUST

COLOURED BODY PORCELAIN TILES / GRES PORCELLANATO COLORATO IN MASSA

Grès cérame coloré dans la masse . Durchgefärbtes Feinsteinzeug . Gres porcelánico coloreado en masa . Керамический гранит окрашенный в массе



OUTDOOR PAVING / PAVIMENTI DA ESTERNO

Sols d'extérieur . Bodenbeläge für Außenbereiche . Pavimentos para exteriores . Уличная плитка

20 mm / 30 mm

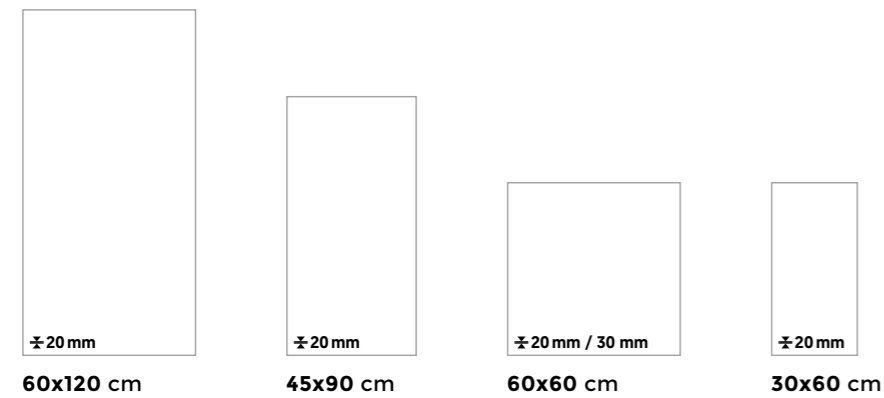

Rectified monocaliber . Rettificato monocalibro . Rectifié monocalibre . Rektifiziert Monokalibriert . Rectificado monocalibre . Одном калибре

- 60x120 cm** $23\frac{5}{8}'' \times 47\frac{1}{4}''$ ∇ 20 mm Ivory / Gold / Silver / Titanium
- 45x90 cm** $17\frac{3}{4}'' \times 35\frac{3}{8}''$ ∇ 20 mm Ivory / Gold / Silver / Titanium
- 60x60 cm** $23\frac{5}{8}'' \times 23\frac{5}{8}''$ ∇ 20 mm Ivory / Gold / Silver / Titanium
- 60x60 cm** $23\frac{5}{8}'' \times 23\frac{5}{8}''$ ∇ 30 mm Gold / Silver / Titanium
- 30x60 cm** $11\frac{3}{4}'' \times 23\frac{5}{8}''$ ∇ 20 mm Ivory / Gold / Silver / Titanium



Ivory



Gold



Silver

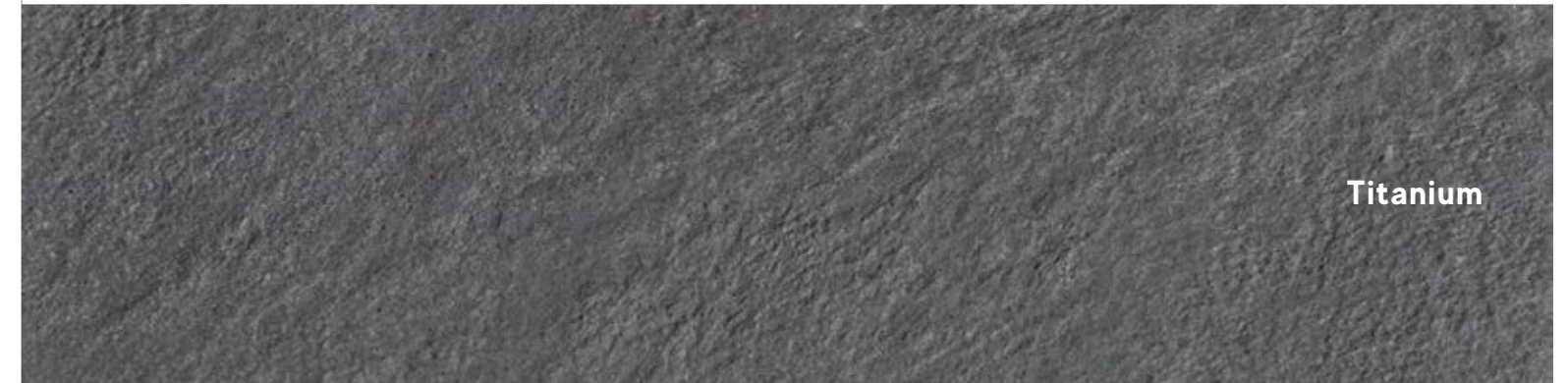

Titanium

TRUST

COLOURED BODY PORCELAIN TILES / GRES PORCELLANATO COLORATO IN MASSA

Grès cérame coloré dans la masse . Durchgefärbtes Feinsteinzeug . Gres porcelánico coloreado en masa . Керамический гранит окрашенный в массе



GRIP SURFACE / SUPERFICIE GRIP

Surface grip . Grip oberfläche . Superficie Grip . Grip поверхность

≙ 9 mm



30x60 cm

Rectified monocaliber . Rettificato monocalibro . Rectifié monocalibre . Rektifiziert Monokalibriert . Rectificado monocalibre . Одном калибре

30x60 cm 11³/₄"x23⁵/₈" ≙ 9 mm Moon / Ivory / Gold / Copper / Silver / Titanium

DECORS



Trust Brick 30x60 cm 11³/₄"x23⁵/₈"
Moon / Ivory / Gold / Copper / Silver / Titanium

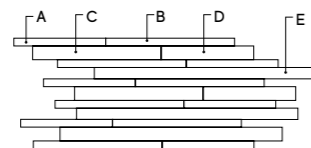

A: 2,1x24,8 cm - 3/₄"x9³/₄"
B: 2,1x34,5 cm - 3/₄"x13⁵/₈"
C: 3,3x34,5 cm - 1¹/₄"x13⁵/₈"
D: 3,3x24,8 cm - 1¹/₄"x9³/₄"
E: 2,5x60 cm - 1"x23⁵/₈"



Trust Mosaico 30x30 cm 11³/₄"x11³/₄"
Moon / Ivory / Gold / Copper / Silver / Titanium

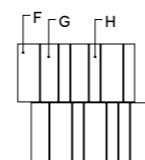

F: 5,6x14,7 cm - 2¹/₄"x5³/₄"
G: 4,5x14,7 cm - 1³/₄"x5³/₄"
H: 2,8x14,7 cm - 1¹/₈"x5³/₄"



Moon



Ivory



Gold



Silver



Copper



Titanium

BLOCK

COLOURED BODY PORCELAIN TILES / GRES PORCELLANATO COLORATO IN MASSA

Grès cérame coloré dans la masse . Durchgefärbtes Feinsteinzeug . Gres porcelánico coloreado en masa . Керамический гранит окрашенный в массе



V2
SLIGHT
VARIATION

OUTDOOR PAVING / PAVIMENTI DA ESTERNO

Sols d'extérieur . Bodenbeläge für Außenbereiche . Pavimentos para exteriores . Уличная плитка

 20 mm

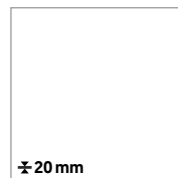

 20 mm

60x60 cm

Rectified monocaliber . Rettificato monocalibro . Rectifié monocalibre . Rektifiziert Monokalibriert . Rectificado monocalibre . Одном калибре

60x60 cm $23\frac{5}{8} \times 23\frac{5}{8}$  20 mm Bianco / Beige / Grigio



Bianco



Beige



Grigio

BLOCK

COLOURED BODY PORCELAIN TILES / GRES PORCELLANATO COLORATO IN MASSA

Grès cérame coloré dans la masse . Durchgefärbtes Feinsteinzeug . Gres porcelánico coloreado en masa . Керамический гранит окрашенный в массе



TEXTURED SURFACE / SUPERFICIE STRUTTURATA

Surface structuré . Strukturiert oberfläche . Superficie estructurado . Структурная поверхность

± 8 mm / 8,6 mm

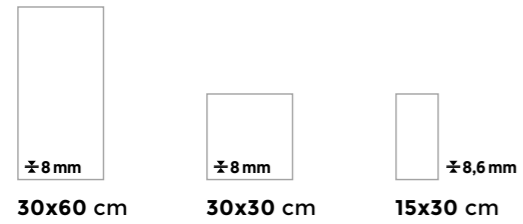

Not rectified monocaliber . Non rettificato monocalibro . Non rectifié monocalibre . Nicht Rektifiziert Monokalibriert . No Rectificado monocalibre . Неретифицированные

30x60 cm 11³/₄"x23⁵/₈" ± 8 mm Bianco / Beige / Grigio / Fumo

30x30 cm 11³/₄"x11³/₄" ± 8 mm Bianco / Beige / Grigio / Fumo

15x30 cm 5⁷/₈"x11³/₄" ± 8,6 mm Bianco / Beige / Grigio / Fumo

DECORS



Block Brick 29,5x60 cm 11⁵/₈"x23⁵/₈"
Bianco / Beige / Grigio / Fumo

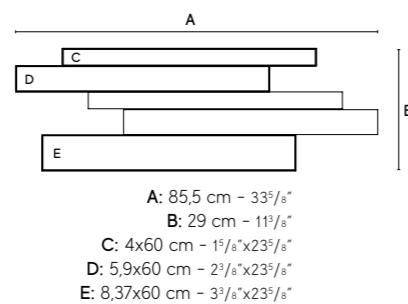

A: 85,5 cm - 33³/₈"
B: 29 cm - 11¹/₈"
C: 4x60 cm - 1⁵/₈"x23⁵/₈"
D: 5,9x60 cm - 2¹/₈"x23⁵/₈"
E: 8,37x60 cm - 3¹/₈"x23⁵/₈"



Bianco



Beige



Grigio



Fumo

DIESIS

COLOURED BODY PORCELAIN TILES / GRES PORCELLANATO COLORATO IN MASSA

Grès cérame coloré dans la masse . Durchgefärbtes Feinsteinzeug . Gres porcelánico coloreado en masa . Керамический гранит окрашенный в массе



OUTDOOR PAVING / PAVIMENTI DA ESTERNO

Sols d'extérieur . Bodenbeläge für Außenbereiche . Pavimentos para exteriores . Уличная плитка

20 mm

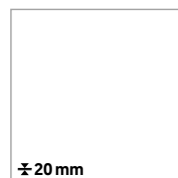

60x60 cm

Rectified monocaliber . Rettificato monocalibro . Rectifié monocalibre . Rektifiziert Monokalibriert . Rectificado monocalibre . Одном калибре

60x60 cm $23\frac{5}{8}'' \times 23\frac{5}{8}''$ 20 mm Avorio / Beige / Greige



Avorio



Beige



Greige

DIESIS

COLOURED BODY PORCELAIN TILES / GRES PORCELLANATO COLORATO IN MASSA

Grès cérame coloré dans la masse . Durchgefärbtes Feinsteinzeug . Gres porcelánico coloreado en masa . Керамический гранит окрашенный в массе



GRIP SURFACE / SUPERFICIE GRIP

Surface grip . Grip oberfläche . Superficie Grip . Grip поверхность

8 mm



± 8 mm

30x60 cm

Rectified monocaliber . Rettificato monocalibro . Rectifié monocalibre . Rektifiziert Monokalibriert . Rectificado monocalibre . Одном калибре

30x60 cm 11³/₄"x23⁵/₈" ± 8 mm Avorio / Beige / Greige



Avorio



Beige



Greige

KAVA

COLOURED BODY PORCELAIN TILES / GRES PORCELLANATO COLORATO IN MASSA

Grès cérame coloré dans la masse . Durchgefärbtes Feinsteinzeug . Gres porcelánico coloreado en masa . Керамический гранит окрашенный в массе



OUTDOOR PAVING / PAVIMENTI DA ESTERNO

Sols d'extérieur . Bodenbeläge für Außenbereiche . Pavimentos para exteriores . Уличная плитка

 20 mm



± 20 mm

45x90 cm

Rectified monocaliber . Rettificato monocalibro . Rectifié monocalibre . Rektifiziert Monokalibriert . Rectificado monocalibre . Одном калибре

45x90 cm 17³/₄"x35³/₈" ± 20 mm Ivory / Silver / Grey



Ivory



Silver



Grey

KAVA

COLOURED BODY PORCELAIN TILES / GRES PORCELLANATO COLORATO IN MASSA

Grès cérame coloré dans la masse . Durchgefärbtes Feinsteinzeug . Gres porcelánico coloreado en masa . Керамический гранит окрашенный в массе



TEXTURED SURFACE / SUPERFICIE STRUTTURATA

Surface structuré . Strukturiert oberfläche . Superficie estructurado . Структурная поверхность

≡ 8 mm / 9 mm



≡ 8 mm

30x60 cm



≡ 9 mm

22,5x45,3 cm

Not rectified monocaliber . Non rettificato monocalibro . Non rectifié monocalibre . Nicht Rektifiziert Monokalibriert . No Rectificado monocalibre .
Неретифицированные

30x60 cm $11\frac{3}{4}'' \times 23\frac{5}{8}''$ ≡ 8 mm Ivory / Silver / Grey

22,5x45,3 cm $8\frac{7}{8}'' \times 17\frac{3}{4}''$ ≡ 9 mm Ivory / Silver / Grey

DECORS



Kaca Brick 29,5x60 cm $11\frac{5}{8}'' \times 23\frac{5}{8}''$
Ivory / Silver / Grey

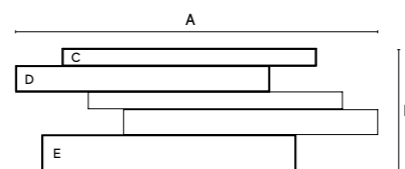

A: 85,5 cm - $33\frac{3}{8}''$
B: 29 cm - $11\frac{3}{8}''$
C: 4x60 cm - $1\frac{1}{8}'' \times 23\frac{5}{8}''$
D: 5,9x60 cm - $2\frac{1}{8}'' \times 23\frac{5}{8}''$
E: 8,37x60 cm - $3\frac{3}{8}'' \times 23\frac{5}{8}''$



Ivory



Silver



Grey

ARKSHADE

COLOURED BODY PORCELAIN TILES / GRES PORCELLANATO COLORATO IN MASSA

Grès cérame coloré dans la masse . Durchgefärbtes Feinsteinzeug . Gres porcelánico coloreado en masa . Керамический гранит окрашенный в массе



V1
UNIFORM
APPEARANCE

GRIP SURFACE / SUPERFICIE GRIP

Surface grip . Grip oberfläche . Superficie Grip . Grip поверхность

 9 mm



30x60 cm

Rectified monocaliber . Rettificato monocalibro . Rectifié monocalibre . Rektifiziert Monokalibriert . Rectificado monocalibre . Одном калибре

30x60 cm $11\frac{3}{4} \times 23\frac{5}{8}$ " \pm 9 mm White / Lead / Grey / Clay / Dove

DECORS



Arkshade Listello 8x60 cm $3\frac{1}{8} \times 23\frac{5}{8}$ "

White / Lead / Grey / Clay / Dove



White

Grey

Clay

Dove

Lead

CONCRETE & RESIN LOOK

BOOST

COLOURED BODY PORCELAIN TILES / GRES PORCELLANATO COLORATO IN MASSA

Grès cérame coloré dans la masse . Durchgefärbtes Feinsteinzeug . Gres porcelánico coloreado en masa . Керамический гранит окрашенный в массе



OUTDOOR PAVING / PAVIMENTI DA ESTERNO

Sols d'extérieur . Bodenbeläge für Außenbereiche . Pavimentos para exteriores . Уличная плитка

20 mm



120x240 cm



± 20 mm

90x90 cm

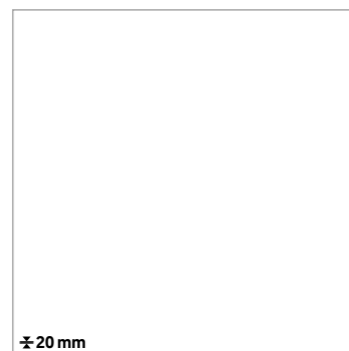

± 20 mm

120x120 cm



± 20 mm

60x120 cm



± 20 mm

60x60 cm

Rectified monocaliber . Rettificato monocalibro . Rectifié monocalibre . Rektifiziert Monokalibriert . Rectificado monocalibre . Одном калибре

120x240 cm 47¹/₄"x94¹/₂" ± 20 mm White / Grey

120x120 cm 47¹/₄"x47¹/₄" ± 20 mm White / Grey / Smoke / Tarmac

60x120 cm 23⁵/₈"x47¹/₄" ± 20 mm White / Grey / Smoke / Tarmac

90x90 cm 35³/₈"x35³/₈" ± 20 mm White / Grey / Smoke / Tarmac

60x60 cm 23⁵/₈"x23⁵/₈" ± 20 mm White / Grey / Smoke / Tarmac



White

Grey

Smoke

Tarmac

CONCRETE & RESIN LOOK

BOOST

COLOURED BODY PORCELAIN TILES / GRES PORCELLANATO COLORATO IN MASSA

Grès cérame coloré dans la masse . Durchgefärbtes Feinsteinzeug . Gres porcelánico coloreado en masa . Керамический гранит окрашенный в массе



V3
MODERATE
VARIATION

GRIP SURFACE / SUPERFICIE GRIP

Surface grip . Grip oberfläche . Superficie Grip . Grip поверхность

9 mm

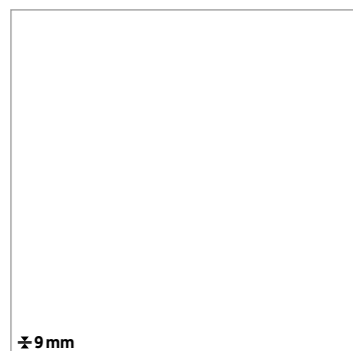

± 9 mm

120x120 cm

Rectified monocaliber . Rettificato monocalibro . Rectifié monocalibre . Rektifiziert Monokalibriert . Rectificado monocalibre . Одном калибре

120x120 cm 47 1/4" x 47 1/4" ± 9 mm White / Pearl / Grey / Smoke / Tarmac



White



Pearl



Grey



Smoke



Tarmac

CONCRETE & RESIN LOOK

BOOST PRO

COLOURED BODY PORCELAIN TILES / GRES PORCELLANATO COLORATO IN MASSA

Grès cérame coloré dans la masse . Durchgefärbtes Feinsteinzeug . Gres porcelánico coloreado en masa . Керамический гранит окрашенный в массе



R11
A+B+C



HEAVY
TRAFFIC



V3
MODERATE
VARIATION

OUTDOOR PAVING / PAVIMENTI DA ESTERNO

Sols d'extérieur . Bodenbeläge für Außenbereiche . Pavimentos para exteriores . Уличная плитка

20 mm

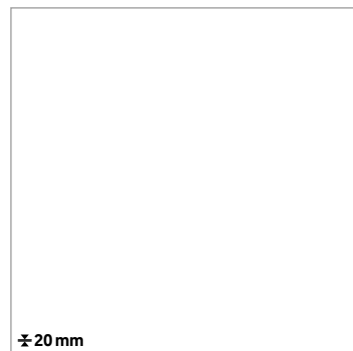

120x120 cm



60x120 cm

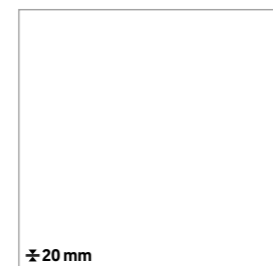

90x90 cm



60x60 cm

Rectified monocaliber . Rettificato monocalibro . Rectifié monocalibre . Rektifiziert Monokalibriert . Rectificado monocalibre . Одном калибре

120x120 cm 47¹/₄"x47¹/₄" Cream / Clay / Taupe / Tobacco

60x120 cm 23⁵/₈"x47¹/₄" Cream / Clay / Taupe / Tobacco

90x90 cm 35³/₈"x35³/₈" Cream / Clay / Taupe / Tobacco

60x60 cm 23⁵/₈"x23⁵/₈" Cream / Clay / Taupe / Tobacco

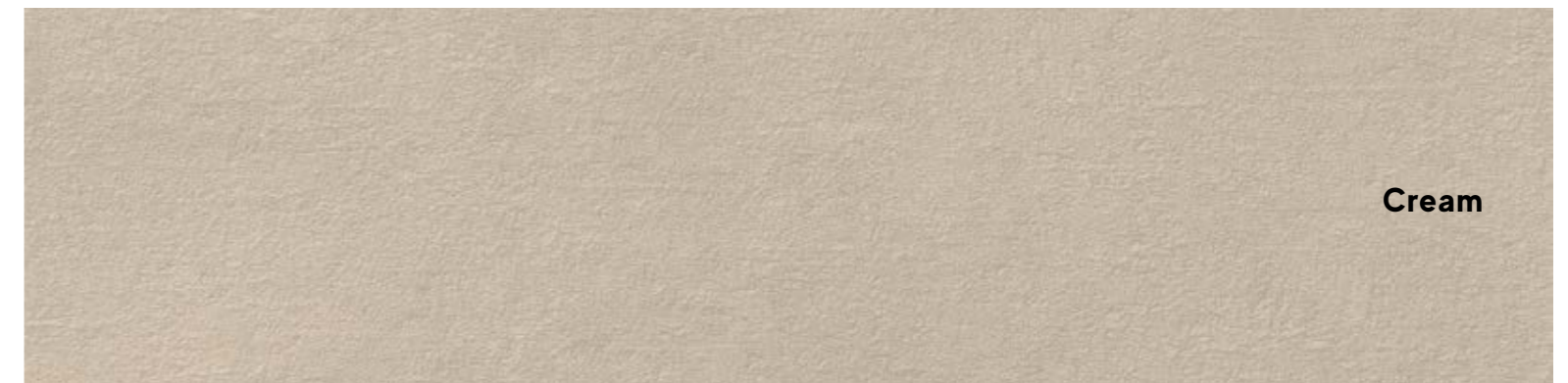

Cream



Clay

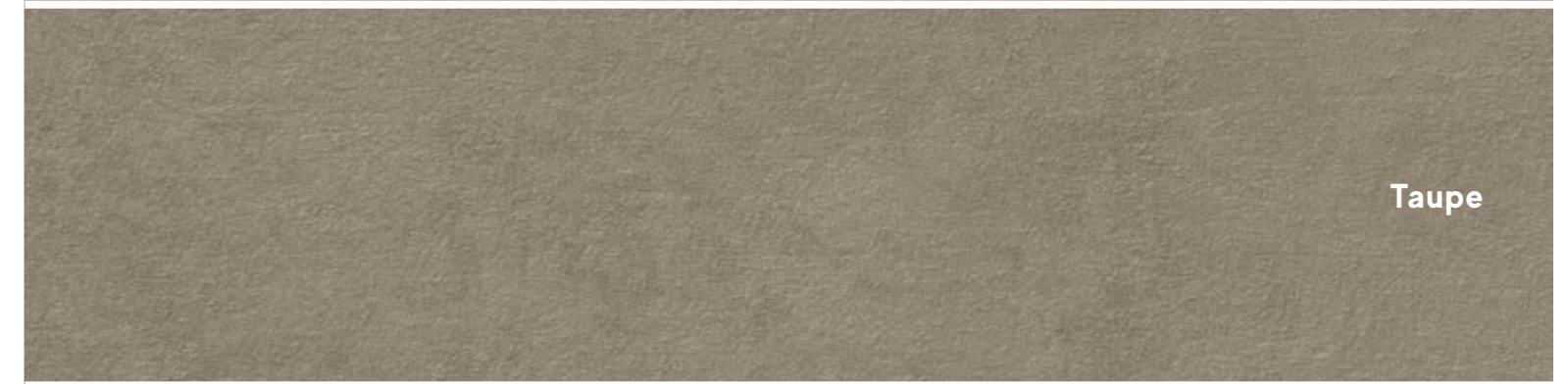

Taupe



Tobacco

CONCRETE & RESIN LOOK

BOOST PRO

COLOURED BODY PORCELAIN TILES / GRES PORCELLANATO COLORATO IN MASSA

Grès cérame coloré dans la masse . Durchgefärbtes Feinsteinzeug . Gres porcelánico coloreado en masa . Керамический гранит окрашенный в массе



V3
MODERATE
VARIATION

GRIP SURFACE / SUPERFICIE GRIP

Surface grip . Grip oberfläche . Superficie Grip . Grip поверхность

≡ 9 mm

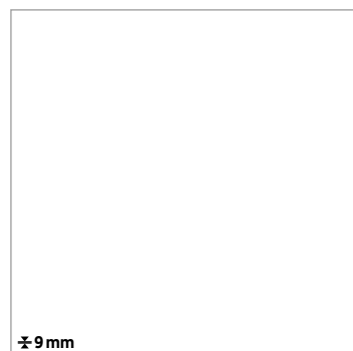

≡ 9 mm

120x120 cm

Rectified monocaliber . Rettificato monocalibro . Rectifié monocalibre . Rektifiziert Monokalibriert . Rectificado monocalibre . Одном калибре

120x120 cm 47 1/4" x 47 1/4" ≡ 9 mm Ivory / Cream / Clay / Taupe / Tobacco



Ivory



Cream

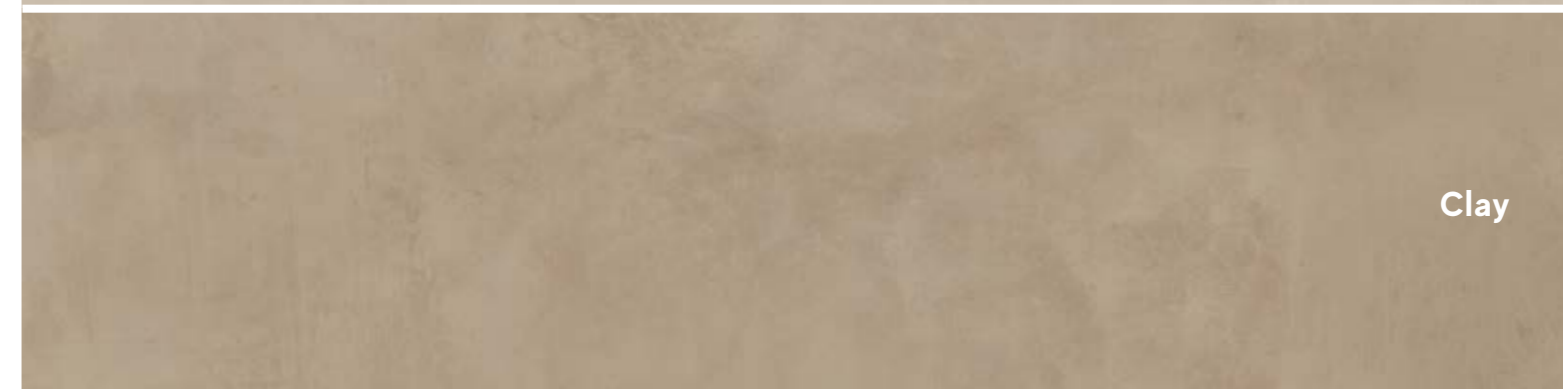

Clay

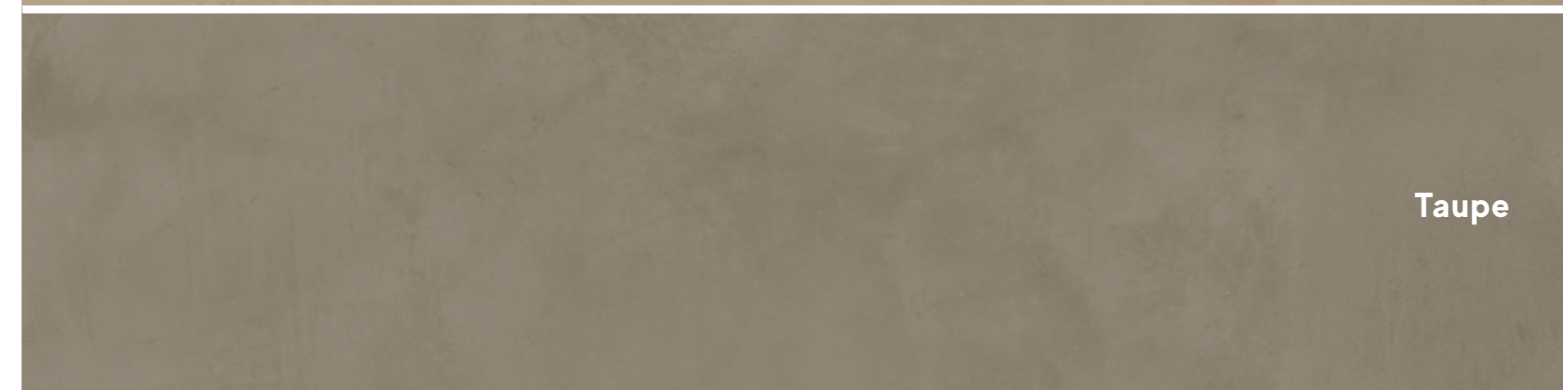

Taupe

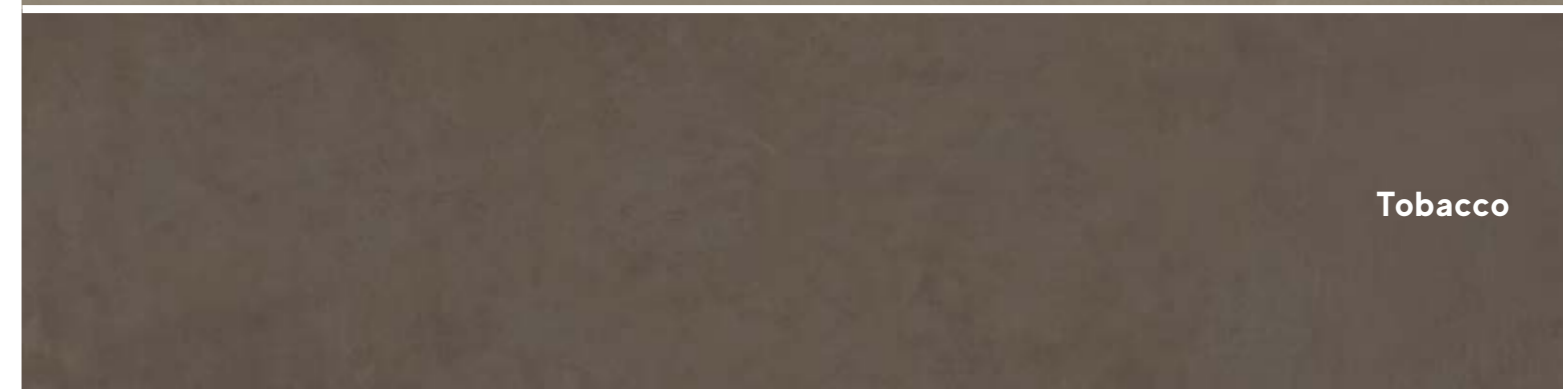

Tobacco

CONCRETE & RESIN LOOK

DWELL

COLOURED BODY PORCELAIN TILES / GRES PORCELLANATO COLORATO IN MASSA

Grès cérame coloré dans la masse . Durchgefärbtes Feinsteinzeug . Gres porcelánico coloreado en masa . Керамический гранит окрашенный в массе



V2
SLIGHT
VARIATION

OUTDOOR PAVING / PAVIMENTI DA ESTERNO

Sols d'extérieur . Bodenbeläge für Außenbereiche . Pavimentos para exteriores . Уличная плитка

 20 mm

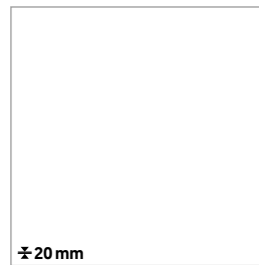

± 20 mm

90x90 cm

Rectified monocaliber . Rettificato monocalibro . Rectifié monocalibre . Rektifiziert Monokalibriert . Rectificado monocalibre . Одном калибре

90x90 cm 35⁵/₈"x35⁵/₈" ± 20 mm Off White / Pearl / Gray / Smoke

DECORS



Dwell Listello 8x60 cm 3¹/₈"x23⁵/₈"

Off White / Pearl / Gray / Dwell Smoke



Off White



Pearl



Gray



Smoke

CONCRETE & RESIN LOOK

PRISM

COLOURED BODY PORCELAIN TILES / GRES PORCELLANATO COLORATO IN MASSA

Grès cérame coloré dans la masse . Durchgefärbtes Feinsteinzeug . Gres porcelánico coloreado en masa . Керамический гранит окрашенный в массе



OUTDOOR PAVING / PAVIMENTI DA ESTERNO

Sols d'extérieur . Bodenbeläge für Außenbereiche . Pavimentos para exteriores . Уличная плитка

20 mm

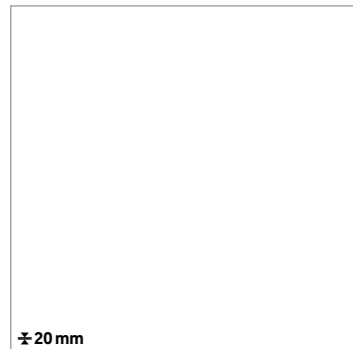

120x120 cm



80x80 cm

Rectified monocaliber . Rettificato monocalibro . Rectifié monocalibre . Rektifiziert Monokalibriert . Rectificado monocalibre . Одном калибре

120x120 cm 47¹/₄"x47¹/₄" 20 mm Cord / Cloud / Fog / Suede

80x80 cm 31¹/₂"x31¹/₂" 20 mm Cord / Cloud / Fog / Suede

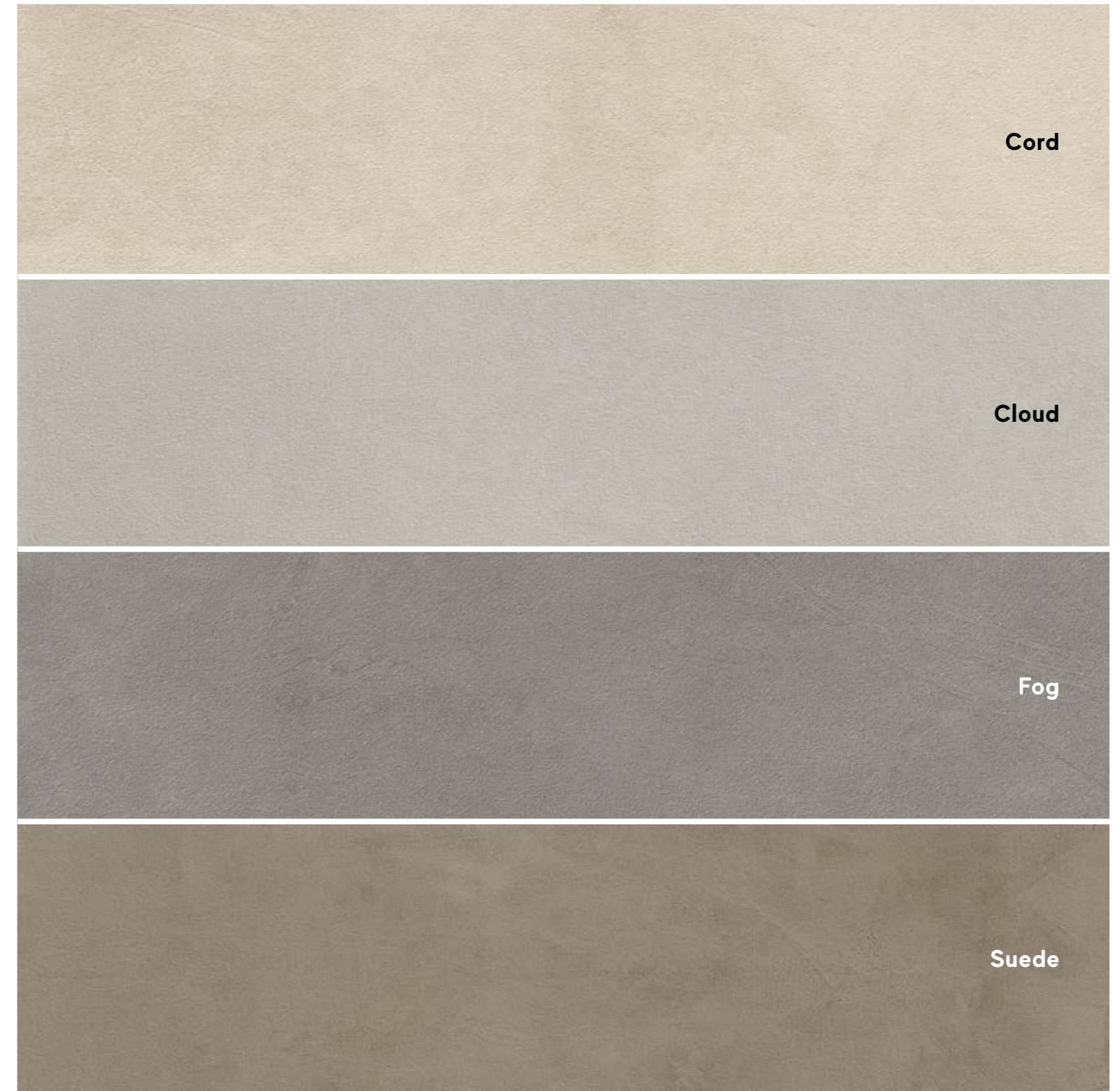

Cord

Cloud

Fog

Suede

CONCRETE & RESIN LOOK

PRISM

COLOURED BODY PORCELAIN TILES / GRES PORCELLANATO COLORATO IN MASSA

Grès cérame coloré dans la masse . Durchgefärbtes Feinsteinzeug . Gres porcelánico coloreado en masa . Керамический гранит окрашенный в массе



V2
SLIGHT
VARIATION

GRIP SURFACE / SUPERFICIE GRIP

Surface grip . Grip oberfläche . Superficie Grip . Grip поверхность

9 mm

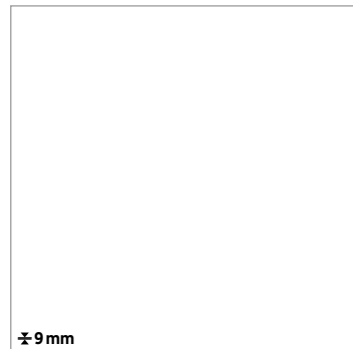

± 9 mm

120x120 cm

Rectified monocaliber . Rettificato monocalibro . Rectifié monocalibre . Rektifiziert Monokalibriert . Rectificado monocalibre . Одном калибре

120x120 cm 47 1/4" x 47 1/4" ± 9 mm Cord / Cloud / Fog / Suede

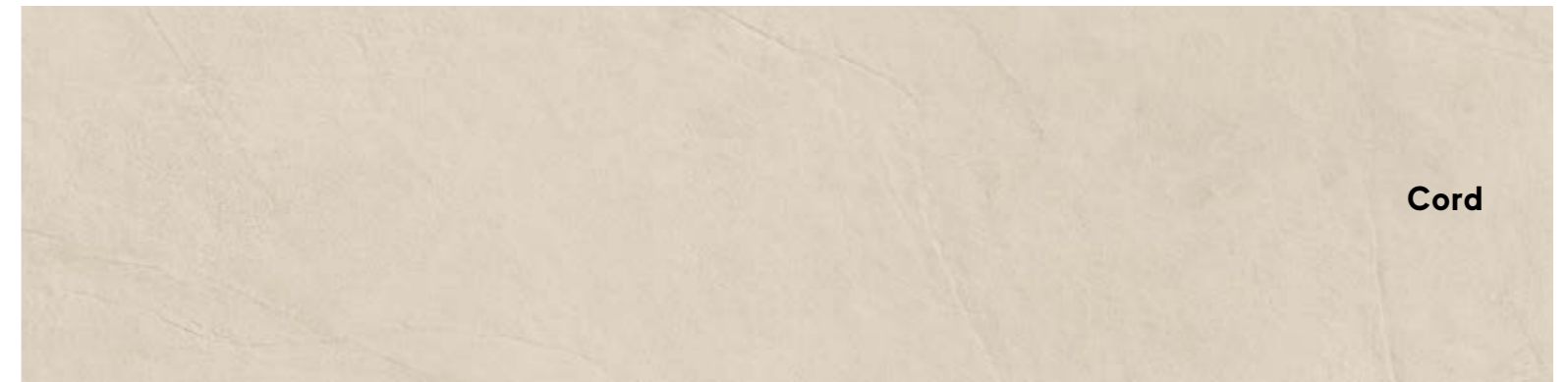

Cord



Cloud



Fog



Suede

CONCRETE & RESIN LOOK

RAW

COLOURED BODY PORCELAIN TILES / GRES PORCELLANATO COLORATO IN MASSA

Grès cérame coloré dans la masse . Durchgefärbtes Feinsteinzeug . Gres porcelánico coloreado en masa . Керамический гранит окрашенный в массе



OUTDOOR PAVING / PAVIMENTI DA ESTERNO

Sols d'extérieur . Bodenbeläge für Außenbereiche . Pavimentos para exteriores . Уличная плитка

20 mm

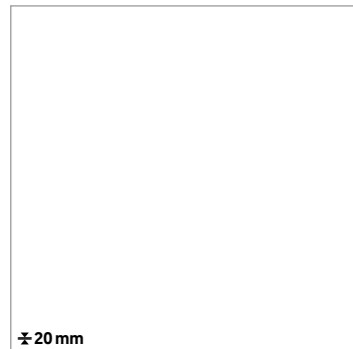

120x120 cm



60x120 cm

Rectified monocaliber . Rettificato monocalibro . Rectifié monocalibre . Rektifiziert Monokalibriert . Rectificado monocalibre . Одном калибре

120x120 cm 47¹/₄"x47¹/₄" 20 mm White / Pearl / Sand / Mud

60x120 cm 23⁵/₈"x47¹/₄" 20 mm White / Pearl / Sand / Mud



White



Pearl



Sand



Mud

CONCRETE & RESIN LOOK

RAW

COLOURED BODY PORCELAIN TILES / GRES PORCELLANATO COLORATO IN MASSA

Grès cérame coloré dans la masse . Durchgefärbtes Feinsteinzeug . Gres porcelánico coloreado en masa . Керамический гранит окрашенный в массе



GRIP SURFACE / SUPERFICIE GRIP

Surface grip . Grip oberfläche . Superficie Grip . Grip поверхность

 9 mm



37,5x75 cm

Rectified monocaliber . Rettificato monocalibro . Rectifié monocalibre . Rektifiziert Monokalibriert . Rectificado monocalibre . Одном калибре

37,5x75 cm $14\frac{3}{4} \times 29\frac{1}{2}$ " \pm 9 mm White / Pearl / Sand / Mud



White



Pearl



Sand



Mud

CONCRETE & RESIN LOOK

FLUX

COLOURED BODY PORCELAIN TILES / GRES PORCELLANATO COLORATO IN MASSA

Grès cérame coloré dans la masse . Durchgefärbtes Feinsteinzeug . Gres porcelánico coloreado en masa . Керамический гранит окрашенный в массе



V2
SLIGHT
VARIATION

OUTDOOR PAVING / PAVIMENTI DA ESTERNO

Sols d'extérieur . Bodenbeläge für Außenbereiche . Pavimentos para exteriores . Уличная плитка

 20 mm

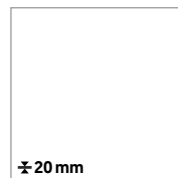

± 20 mm

60x60 cm

Rectified monocaliber . Rettificato monocalibro . Rectifié monocalibre . Rektifiziert Monokalibriert . Rectificado monocalibre . Одном калибре

60x60 cm 23⁵/₈"x23⁵/₈" ± 20 mm Bone / Concrete / Coke



Bone



Concrete



Coke

CONCRETE & RESIN LOOK

FLUX

COLOURED BODY PORCELAIN TILES / GRES PORCELLANATO COLORATO IN MASSA

Grès cérame coloré dans la masse . Durchgefärbtes Feinsteinzeug . Gres porcelánico coloreado en masa . Керамический гранит окрашенный в массе



GRIP SURFACE / SUPERFICIE GRIP

Surface grip . Grip oberfläche . Superficie Grip . Grip поверхность

8 mm



30x60 cm

Rectified monocaliber . Rettificato monocalibro . Rectifié monocalibre . Rektifiziert Monokalibriert . Rectificado monocalibre . Одном калибре

30x60 cm ^{11³/₄"x23⁵/₈"} \pm 8 mm Bone / Sand / Concrete / Coke



Bone



Sand



Concrete

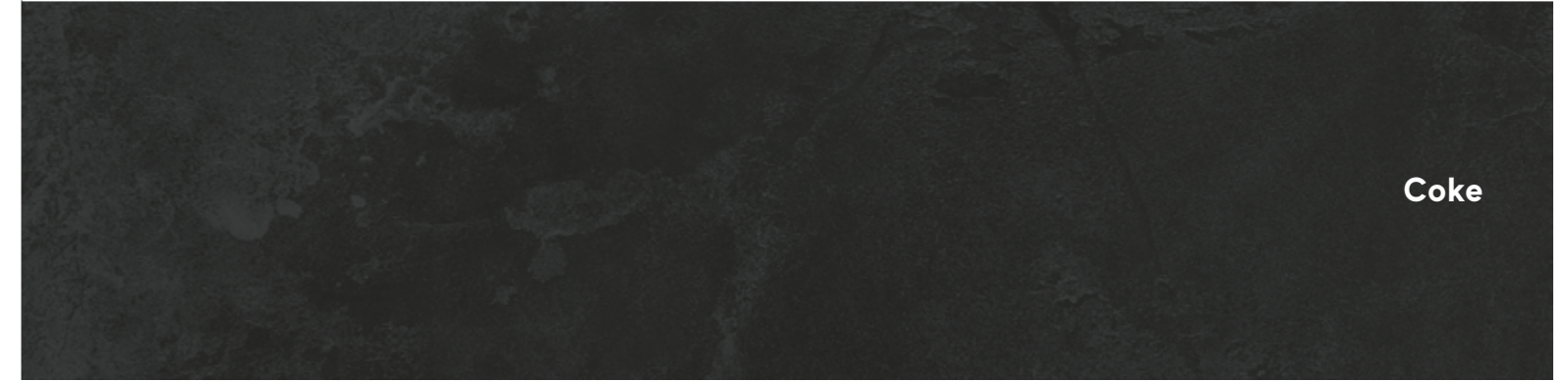

Coke

CONCRETE & RESIN LOOK

ARBOR

COLOURED BODY PORCELAIN TILES / GRES PORCELLANATO COLORATO IN MASSA

Grès cérame coloré dans la masse . Durchgefärbtes Feinsteinzeug . Gres porcelánico coloreado en masa . Керамический гранит окрашенный в массе

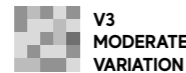

V3
MODERATE
VARIATION

GRIP SURFACE / SUPERFICIE GRIP

Surface grip . Grip oberfläche . Superficie Grip . Grip поверхность

± 9 mm



± 9 mm

15x90 cm

Rectified monocaliber . Rettificato monocalibro . Rectifié monocalibre . Rektifiziert Monokalibriert . Rectificado monocalibre . Одном калибре

15x90 cm 5⁷/₈"x35³/₈" ± 9 mm Almond / Grey / Natural / Cognac / Arbor Tobacco

DECORS

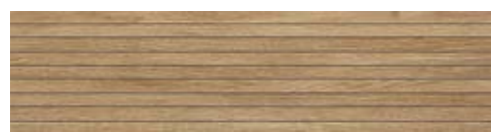

Arbor Tatami 22,5x90 cm 8⁷/₈"x35³/₈"

Arbor Almond / Arbor Grey / Arbor Natural /
Arbor Cognac / Arbor Tobacco

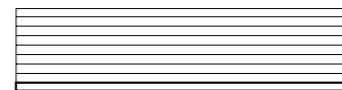

2,3x90 cm - 7¹/₈"x35³/₈"



Almond



Grey



Natural



Cognac



Tobacco

AXI

COLOURED BODY PORCELAIN TILES / GRES PORCELLANATO COLORATO IN MASSA

Grès cérame coloré dans la masse . Durchgefärbtes Feinsteinzeug . Gres porcelánico coloreado en masa . Керамический гранит окрашенный в массе



R11
A+B+C



H
HEAVY
TRAFFIC



V2
SLIGHT
VARIATION

White Pine / Grey Timber



V3
MODERATE
VARIATION

Golden Oak / Brown Chestnut

OUTDOOR PAVING / PAVIMENTI DA ESTERNO

Sols d'extérieur . Bodenbeläge für Außenbereiche . Pavimentos para exteriores . Уличная плитка

20 mm

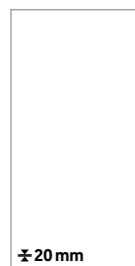

± 20 mm
45x90 cm



± 20 mm
60x60 cm

Rectified monocaliber . Rettificato monocalibro . Rectifié monocalibre . Rektifiziert Monokalibriert . Rectificado monocalibre . Одном калибре

45x90 cm 17³/₄"x35³/₈" ± 20 mm White Pine / Grey Timber / Golden Oak / Brown Chestnut

60x60 cm 23⁵/₈"x23⁵/₈" ± 20 mm Grey Timber / Brown Chestnut



White Pine

Grey Timber

Brown Chestnut

Golden Oak

WOOD LOOK

AXI

COLOURED BODY PORCELAIN TILES / GRES PORCELLANATO COLORATO IN MASSA

Grès cérame coloré dans la masse . Durchgefärbtes Feinsteinzeug . Gres porcelánico coloreado en masa . Керамический гранит окрашенный в массе



V2 SLIGHT VARIATION



V3 MODERATE VARIATION

White Pine / Grey Timber

Silver Fir / Golden Oak / Brown Chestnut / Dark Oak

TEXTURED SURFACE / SUPERFICIE STRUTTURATA

Surface structurée . Strukturiert oberfläche . Superficie estructurado . Структурная поверхность

± 9,5 mm



± 9,5 mm

22,5x90 cm

Rectified monocaliber . Rettificato monocalibro . Rectifié monocalibre . Rektifiziert Monokalibriert . Rectificado monocalibre . Одном калибре

22,5x90 cm 8⁷/₈"x35³/₈" ± 9,5 mm White Pine / Silver Fir / Grey Timber / Golden Oak / Brown Chestnut / Dark Oak

DECORS



Axi Tatami 22,5x90 cm 8⁷/₈"x35³/₈"

White Pine / Silver Fir / Grey Timber / Golden Oak / Brown Chestnut / Dark Oak



Axi Treccia 28x53 cm 11"x20⁷/₈"

White Pine / Silver Fir / Grey Timber / Golden Oak / Brown Chestnut / Dark Oak

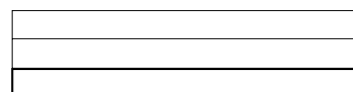

7,2x89,5 cm - 2⁷/₈"x35³/₈"

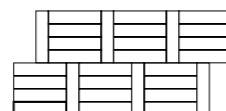

3,3x14 cm - 1¹/₄"x5¹/₂"



White Pine



Silver Fir

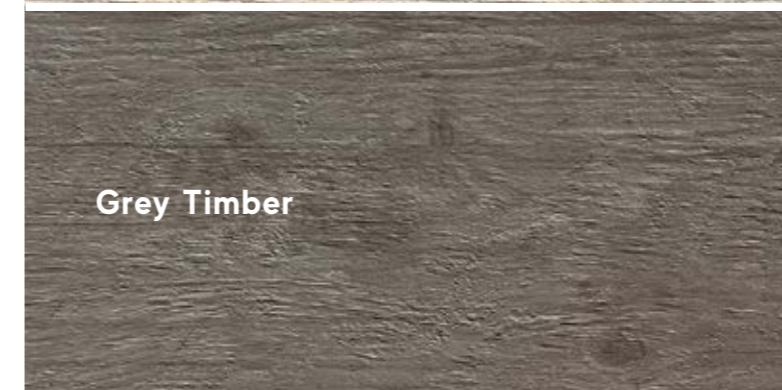

Grey Timber



Golden Oak



Brown Chestnut

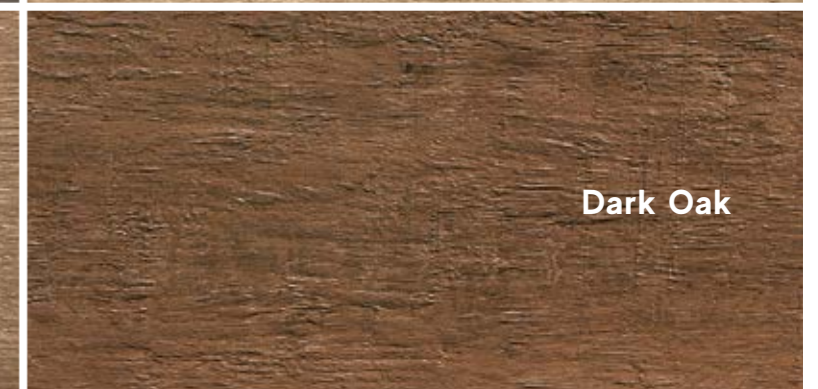

Dark Oak

ETIC PRO

COLOURED BODY PORCELAIN TILES / GRES PORCELLANATO COLORATO IN MASSA

Grès cérame coloré dans la masse . Durchgefärbtes Feinsteinzeug . Gres porcelánico coloreado en masa . Керамический гранит окрашенный в массе



OUTDOOR PAVING / PAVIMENTI DA ESTERNO

Sols d'extérieur . Bodenbeläge für Außenbereiche . Pavimentos para exteriores . Уличная плитка

20 mm



20 mm

30x120 cm

Rectified monocaliber . Rettificato monocalibro . Rectifié monocalibre . Rektifiziert Monokalibriert . Rectificado monocalibre . Одном калибре

30x120 cm $11\frac{3}{4} \times 47\frac{1}{4}$ 20 mm Rovere Venice / Noce Hickory

ETIC PRO

COLOURED BODY PORCELAIN TILES / GRES PORCELLANATO COLORATO IN MASSA

Grès cérame coloré dans la masse . Durchgefärbtes Feinsteinzeug . Gres porcelánico coloreado en masa . Керамический гранит окрашенный в массе



V3
MODERATE
VARIATION

GRIP SURFACE / SUPERFICIE GRIP

Surface grip . Grip oberfläche . Superficie Grip . Grip поверхность

9 mm



±9mm

22,5x90 cm

Rectified monocaliber . Rettificato monocalibro . Rectifié monocalibre . Rektifiziert Monokalibriert . Rectificado monocalibre . Одном калибре

22,5x90 cm 8⁷/₈"x35³/₈" ± 9 mm Rovere Venice / Noce Hickory



Rovere Venice

Noce Hickory

WOOD LOOK

DECORS



Etic Pro Tatami 22,5x90 cm 8⁷/₈"x35³/₈"
Rovere Venice / Noce Hickory

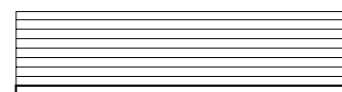

2,3x90 cm - 7¹/₈"x35³/₈"

EXENCE

COLOURED BODY PORCELAIN TILES / GRES PORCELLANATO COLORATO IN MASSA

Grès cérame coloré dans la masse . Durchgefärbtes Feinsteinzeug . Gres porcelánico coloreado en masa . Керамический гранит окрашенный в массе



OUTDOOR PAVING / PAVIMENTI DA ESTERNO

Sols d'extérieur . Bodenbeläge für Außenbereiche . Pavimentos para exteriores . Уличная плитка

 20 mm



Almond



Amber



 20 mm

30x120 cm

Rectified monocaliber . Rettificato monocalibro . Rectifié monocalibre . Rektifiziert Monokalibriert . Rectificado monocalibre . Одном калибре

30x120 cm $11\frac{3}{4} \times 47\frac{1}{4}$  20 mm Almond / Amber

EXENCE

COLOURED BODY PORCELAIN TILES / GRES PORCELLANATO COLORATO IN MASSA

Grès cérame coloré dans la masse . Durchgefärbtes Feinsteinzeug . Gres porcelánico coloreado en masa . Керамический гранит окрашенный в массе



GRIP SURFACE / SUPERFICIE GRIP

Surface grip . Grip oberfläche . Superficie Grip . Grip поверхность

9 mm



± 9 mm

18,5x150 cm

Rectified monocaliber . Rettificato monocalibro . Rectifié monocalibre . Rektifiziert Monokalibriert . Rectificado monocalibre . Одном калибре

18,5x150 cm 7 1/4"x59" ± 9 mm Vanilla / Almond / Amber



WOOD LOOK

DECORS

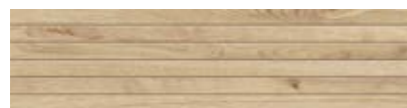

Exence Tatami 18,5x75 cm 7 1/4"x29 1/2"
Vanilla / Almond / Amber

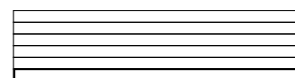

2,85x74,4 cm - 1 1/8"x29 1/8"

NASH

COLOURED BODY PORCELAIN TILES / GRES PORCELLANATO COLORATO IN MASSA

Grès cérame coloré dans la masse . Durchgefärbtes Feinsteinzeug . Gres porcelánico coloreado en masa . Керамический гранит окрашенный в массе



GRIP SURFACE / SUPERFICIE GRIP

Surface grip . Grip oberfläche . Superficie Grip . Grip поверхность

9 mm



±9 mm

20x120 cm

Rectified monocaliber . Rettificato monocalibro . Rectifié monocalibre . Rektifiziert Monokalibriert . Rectificado monocalibre . Одном калибре

20x120 cm 7⁷/₈"x47¹/₄" ± 9 mm White Wood / Greige / Gray Wood / Dark Oak / Light Brown



White Wood



Greige



Gray Wood



Dark Oak



Light Brown

BLAZE

COLOURED BODY PORCELAIN TILES / GRES PORCELLANATO COLORATO IN MASSA

Grès cérame coloré dans la masse . Durchgefärbtes Feinsteinzeug . Gres porcelánico coloreado en masa . Керамический гранит окрашенный в массе

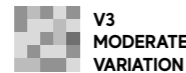

OUTDOOR PAVING / PAVIMENTI DA ESTERNO

Sols d'extérieur . Bodenbeläge für Außenbereiche . Pavimentos para exteriores . Уличная плитка

20 mm

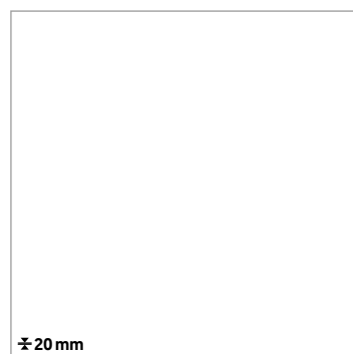

120x120 cm



60x60 cm

Rectified monocaliber . Rettificato monocalibro . Rectifié monocalibre . Rektifiziert Monokalibriert . Rectificado monocalibre . Одном калибре

120x120 cm 47¹/₄"x47¹/₄" 20 mm Corten

60x60 cm 23⁵/₈"x23⁵/₈" 20 mm Corten

GRIP SURFACE / SUPERFICIE GRIP

Surface grip . Grip oberfläche . Superficie Grip . Grip поверхность

9 mm



37,5x75 cm

Rectified monocaliber . Rettificato monocalibro . Rectifié monocalibre . Rektifiziert Monokalibriert . Rectificado monocalibre . Одном калибре

37,5x75 cm 14³/₄"x29¹/₂" 9 mm Aluminium / Iron / Corten

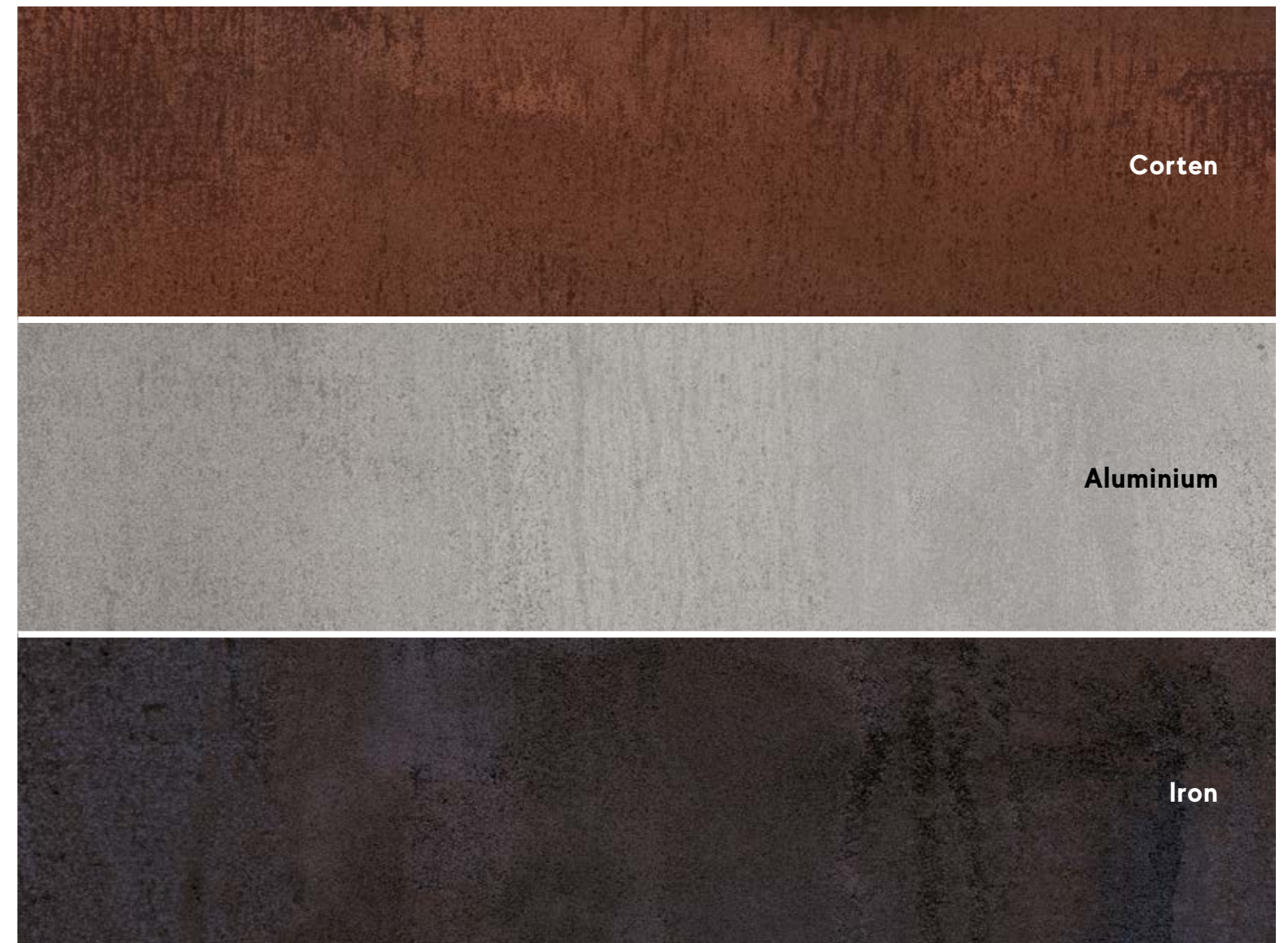

Corten

Aluminium

Iron

MARVEL PRO

COLOURED BODY PORCELAIN TILES / GRES PORCELLANATO COLORATO IN MASSA

Grès cérame coloré dans la masse . Durchgefärbtes Feinsteinzeug . Gres porcelánico coloreado en masa . Керамический гранит окрашенный в массе



V2 SLIGHT VARIATION



V3 MODERATE VARIATION

R11 A+B

HEAVY TRAFFIC

Crema Delicato

Statuario Select / Grey Fleury

TEXTURED SURFACE / SUPERFICIE STRUTTURATA

Surface structuré . Strukturiert oberfläche . Superficie estructurado . Структурная поверхность

≠ 9 mm



30x60 cm

Rectified monocaliber . Rettificato monocalibro . Rectifié monocalibre . Rektifiziert Monokalibriert . Rectificado monocalibre . Одном калибре

30x60 cm 11³/₄"x23⁵/₈" ≠ 9 mm Statuario Select / Crema Delicato / Grey Fleury



Statuario Select



Crema Delicato



Grey Fleury



TECHNICAL SPECIFICATIONS

TRIM TILES / PEZZI SPECIALI

± 20 mm

			AIX	AXI	BLAZE	BOOST	BOOST PRO	BRAVE	DOLMEN PRO	DWELL	ETIC PRO	EXENCE	KLIF	KONE	LIMS	MARVEL STONE	NORDE	PRISM	RAW	TRUST
Lineare	30x60 cm	11 ³ / ₄ "x23 ⁵ / ₈ "	•	•	•	•	•	•					•	•	•	•	•	•	•	•
	33x120 cm	13"x47 ¹ / ₄ "	•		•	•	•	•	•						•	•	•	•	•	•
	30x120 cm	11 ³ / ₄ "x47 ¹ / ₄ "									•	•								
Round	60x90 cm	23 ⁵ / ₈ "x35 ³ / ₈ "	•														•			
	45x90 cm	17 ³ / ₄ "x35 ³ / ₈ "		•		•	•	•		•			•							•
	40x80 cm	15 ³ / ₄ "x31 ¹ / ₂ "															•	•		
Round Angolare Dx/Sx	30x60 cm	11 ³ / ₄ "x23 ⁵ / ₈ "	•	•	•	•	•	•					•	•	•	•	•	•	•	•
	33x120 cm	13"x47 ¹ / ₄ "	•		•	•	•	•	•						•	•	•	•	•	•
	30x120 cm	11 ³ / ₄ "x47 ¹ / ₄ "									•	•								
	30x60 cm	11 ³ / ₄ "x23 ⁵ / ₈ "	•	•	•	•	•	•					•	•	•	•	•	•	•	•
	60x90 cm	23 ⁵ / ₈ "x35 ³ / ₈ "	•														•			
	40x80 cm	15 ³ / ₄ "x31 ¹ / ₂ "															•	•		
Round	60x60 cm	23 ⁵ / ₈ "x23 ⁵ / ₈ "	•	•	•	•	•	•					•	•	•	•	•	•	•	•
Round Angolare	60x60 cm	23 ⁵ / ₈ "x23 ⁵ / ₈ "	•	•	•	•	•	•					•	•	•	•	•	•	•	•
Gradino Round	30x60 cm	11 ³ / ₄ "x23 ⁵ / ₈ "	•	•	•	•	•	•					•	•	•	•	•	•	•	•
Gradino Round Angolare Dx/Sx	30x60 cm	11 ³ / ₄ "x23 ⁵ / ₈ "	•	•	•	•	•	•					•	•	•	•	•	•	•	•
Elemento L	33x120 cm	13"x47 ¹ / ₄ "	•		•	•	•	•	•						•	•	•	•	•	•
	33x90 cm	13"x35 ³ / ₈ "	•	•		•	•	•		•							•			•
	33x80 cm	13"x31 ¹ / ₂ "															•	•		
	20x60 cm	7 ⁷ / ₈ "x23 ⁵ / ₈ "	•	•	•	•	•	•	•				•	•	•	•	•	•	•	•
Elemento L Angolare	33x33 cm	13"x13"	•		•	•	•	•	•	•							•	•	•	•
	20x20 cm	7 ⁷ / ₈ "x7 ⁷ / ₈ "	•		•	•	•	•					•	•	•	•	•	•	•	•
Elemento L Angolare Dx/Sx	20x20 cm	7 ⁷ / ₈ "x7 ⁷ / ₈ "		•																
	33x33 cm	13"x13"		•																
Alzata	30x120 cm	11 ³ / ₄ "x47 ¹ / ₄ "									•	•								
	20x120 cm	7 ⁷ / ₈ "x47 ¹ / ₄ "	•		•	•	•	•	•								•	•	•	•
	20x90 cm	7 ⁷ / ₈ "x35 ³ / ₈ "	•	•		•	•	•	•	•							•			•
Top	30x120 cm	11 ³ / ₄ "x47 ¹ / ₄ "	•		•	•	•	•	•		•	•					•	•	•	•
	30x60 cm	11 ³ / ₄ "x23 ⁵ / ₈ "	•	•	•	•	•	•	•				•	•	•	•	•	•	•	•
Costa Design	33x120 cm	13"x47 ¹ / ₄ "	•		•	•	•	•	•								•	•	•	•
Bordo Piscina	30x60 cm	11 ³ / ₄ "x23 ⁵ / ₈ "	•	•	•	•	•	•					•	•	•	•	•	•	•	•
Bordo Piscina Angolare Dx/Sx	30x60 cm	11 ³ / ₄ "x23 ⁵ / ₈ "	•	•	•	•	•	•					•	•	•	•	•	•	•	•
Griglia	20x60 cm	7 ⁷ / ₈ "x23 ⁵ / ₈ "	•	•	•	•	•	•					•	•	•	•	•	•	•	•
	15x60 cm	5 ⁷ / ₈ "x23 ⁵ / ₈ "	•	•		•	•	•					•	•	•	•	•	•	•	•
Griglia Angolare Dx/Sx	20x60 cm	7 ⁷ / ₈ "x23 ⁵ / ₈ "	•	•	•	•	•	•					•	•	•	•	•	•	•	•
	15x60 cm	5 ⁷ / ₈ "x23 ⁵ / ₈ "	•	•	•	•	•	•					•	•	•	•	•	•	•	•
Curve	60x60 cm	23 ⁵ / ₈ "x23 ⁵ / ₈ "	•	•	•	•	•	•					•	•	•	•	•	•	•	•
Smussato	30x60 cm	11 ³ / ₄ "x23 ⁵ / ₈ "	•	•	•	•	•	•					•	•	•	•	•	•	•	•

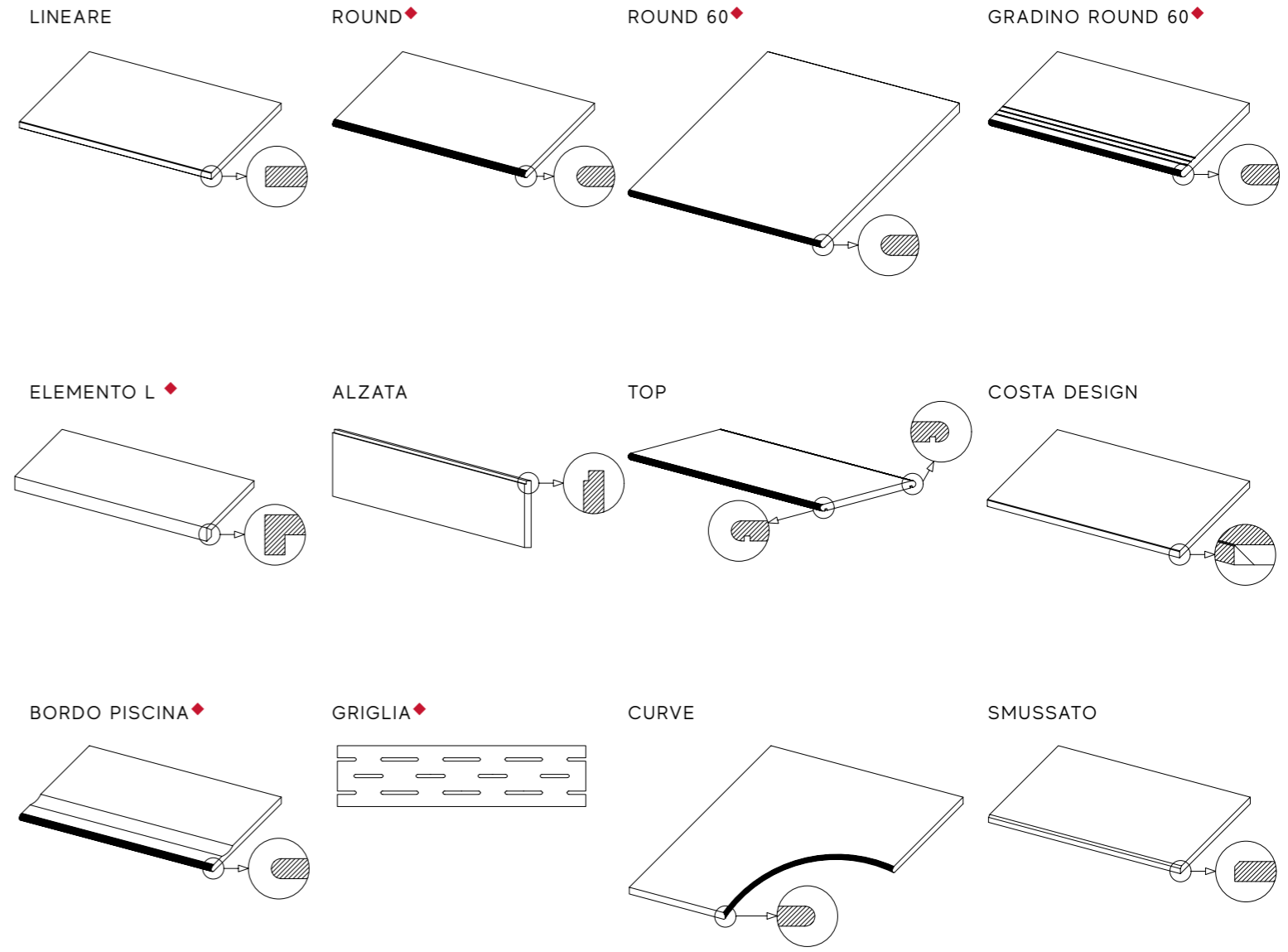

◆ Right/left angular elements are available / Sono disponibili gli elementi angolari dx/sx

LASTRA STEPS

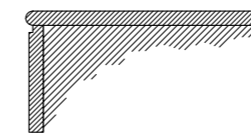

Round + Alzata

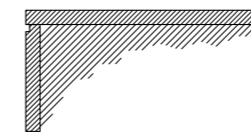

Lineare + Alzata

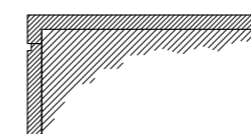

Elemento L + Alzata



AVAILABLE SIZES / FORMATI DISPONIBILI

INDOOR

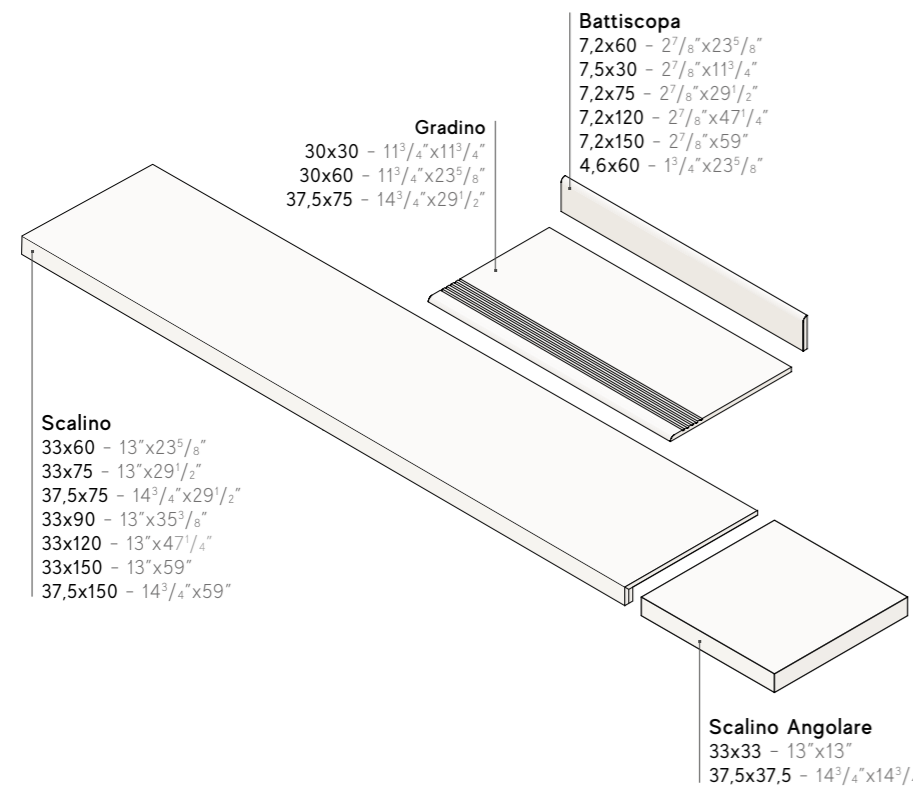

OUTDOOR

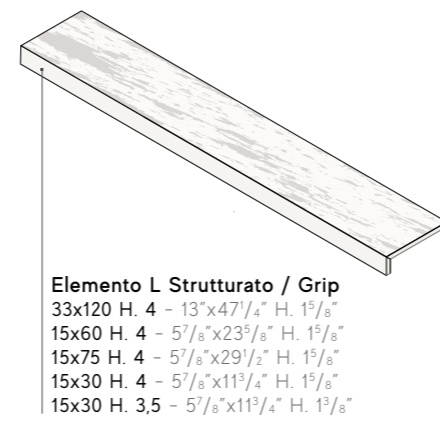

Battiscopa Sagomato

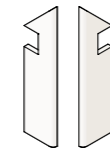

Battiscopa Sag. Scala Dx / Sx
 7,5x30 - 3"x11³/₄"
 7,2x30 - 2⁷/₈"x11³/₄"

WOOD LOOK

INDOOR

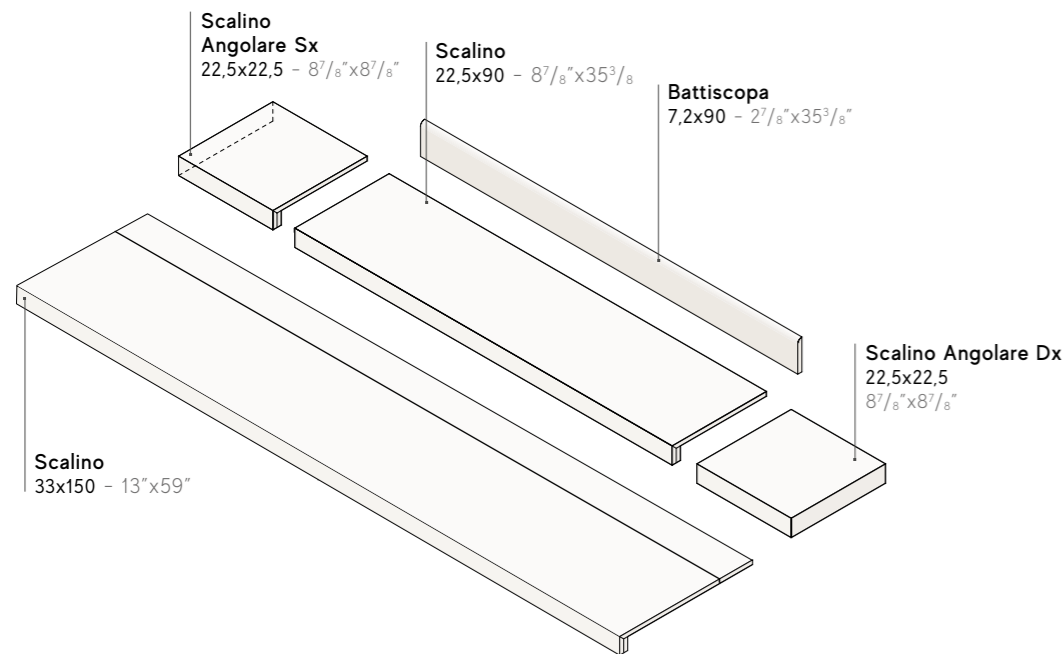

OUTDOOR

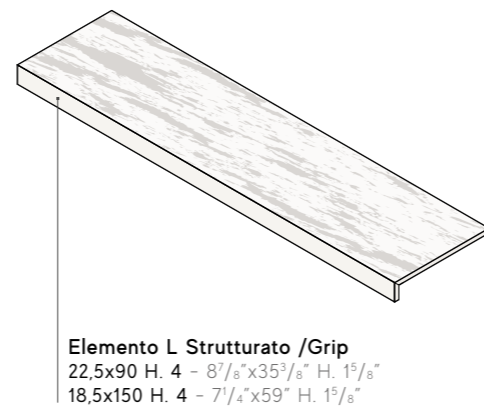

TECHNICAL SPECIFICATIONS / SPECIFICHE TECNICHE

GRADINO

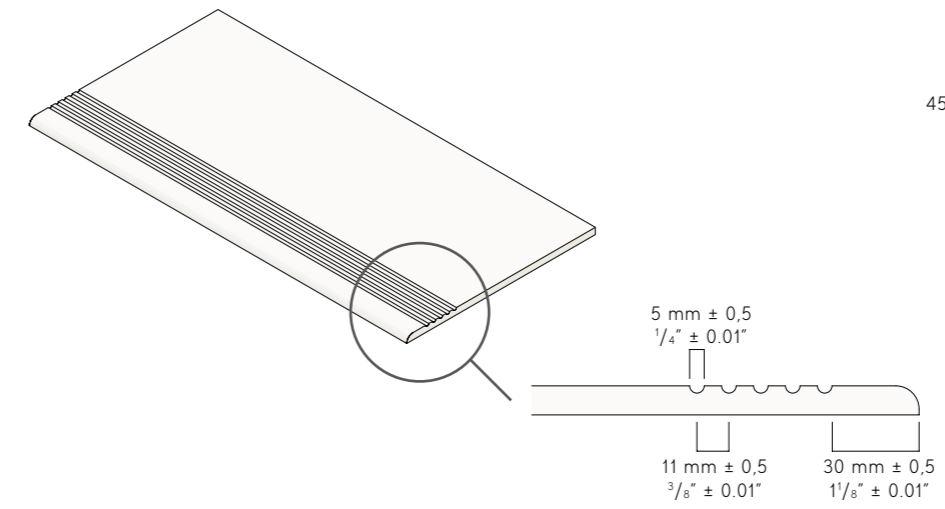

BATTISCOPA SAGOMATO

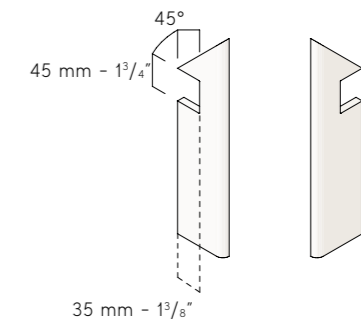

SCALINO

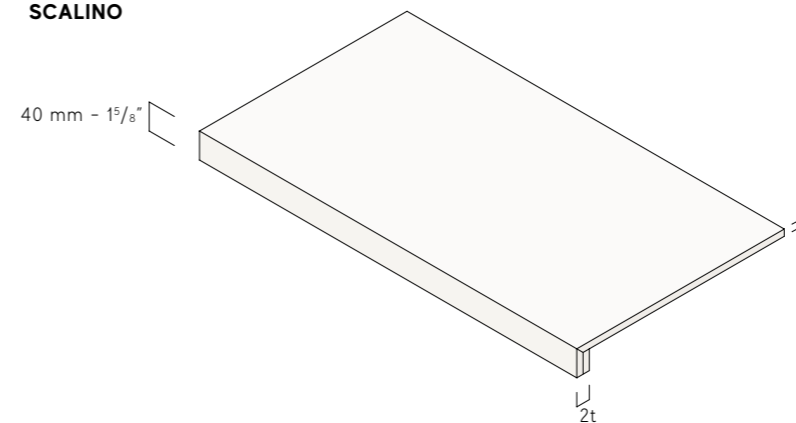

ELEMENTO L STRUTTURATO/GRIP

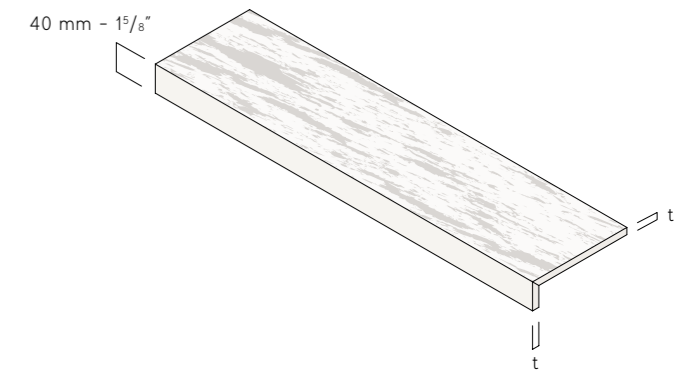

SCALINO ANGOLARE

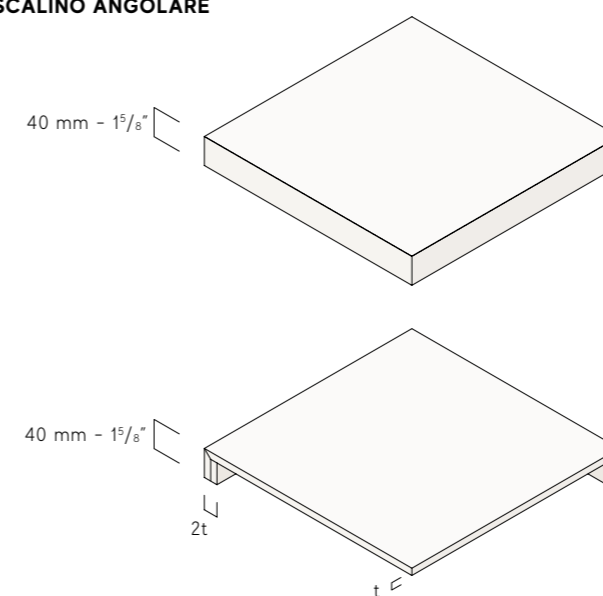

t = thickness

RECOMMENDATIONS FOR RAISED INSTALLATION NORTH AMERICA AND OCEANIA MARKET SPECIFICATION

RACCOMANDAZIONI PER LA POSA SOPRAELEVATA / EMPFEHLUNGEN FÜR DIE VERLEGUNG ALS DOPPELBODEN / CONSEILS POUR LA POSE SURÉLEVÉE / RECOMENDACIONES PARA LA COLOCACIÓN SOBREELEVADA / РЕКОМЕНДАЦИИ ПО УКЛАДКЕ В ВИДЕ ФАЛЬШПОЛА

NORTH AMERICA AND OCEANIA MARKET SPECIFICATION

Size 23^{5/8}"x23^{5/8}" - 60x60 cm in 3/4" - 20 mm thickness

For the raised installation of 23^{5/8}"x23^{5/8}" - 60x60 slabs in 3/4" - 20mm thickness, a maximum raise of the foot plan of 3/4" - 2 cm is recommended.

Sizes 17^{3/4}"x35^{3/8}" - 45x90, 23^{5/8}"x35^{3/8}" - 60x90, 31^{1/2}"x31^{1/2}" - 80x80, 36"x36" - 90x90, 11^{3/4}"x47^{1/4}" - 30x120, 15^{3/4}"x 47^{1/4}" - 40x120, 23^{5/8}"x47^{1/4}" - 60x120 in 3/4", 48"x48" - 120x120, 47^{1/4}"x94^{1/2}" - 120x240 - 20 mm thickness

The 17^{3/4}"x35^{3/8}" - 45x90, 31^{1/2}"x31^{1/2}" - 80x80, 36"x36" - 90x90, 11^{3/4}"x47^{1/8}" - 30x120, 15^{3/4}"x 47^{1/4}" - 40x120 and 23^{5/8}"x47^{1/4}" - 60x120 cm, 48"x48" - 120x120, 47^{1/4}"x94^{1/2}" - 120x240 sizes in 3/4" - 20mm thickness are suitable for installation onto footing, gravel, sand, grass or onto supports at a maximum raised of 3/4" - 2cm and using 6 supports per slab in order to uniformly distribute the load.

SPECIFICHE PER I MERCATI NORD AMERICA E OCEANIA

Formato 60x60 cm - 20 mm di Spessore

Per la posa delle lastre 60x60 in 20mm di spessore, in applicazione sopraelevata, si raccomanda una sopraelevazione massima del piano di calpestio non superiore a 2cm.

Formati 45x90-60x90-80x80-90x90-30x120-40x120-60x120-120x120-120x240 - 20 mm di Spessore

I formati 45x90, 60x90, 80x80, 90x90, 30x120, 40x120, 60x120, 120x120, 120x240 in 20mm di spessore sono ritenuti idonei per la posa su massetto, su ghiaia, su sabbia, su erba o su supporti ad una altezza massima di 2cm utilizzando 6 supporti per lastra in modo da distribuire uniformemente i carichi.

EMPFEHLUNGEN FÜR DIE VERLEGUNG VON LASTRA 20MM ALS DOPPELBODEN

Format 60x60 cm - 20 mm Stärke

Für die Verlegung von Lastra als Doppelboden im Format 60x60 - 20mm Stärke wird eine Aufbauhöhe von maximal 2cm empfohlen.

Formate 45x90-60x90-80x80-90x90-30x120-40x120-60x120-120x120-120x240 - 20 mm Stärke

Die Formate 45x90, 60x90, 80x80, 90x90, 30x120, 40x120, 60x120, 120x120, 120x240 in einer Stärke von 20 mm eignen sich für eine Verlegung auf Estrich, Kies, Sand und Rasen oder auf Träger mit einer maximalen Aufbauhöhe der Trittlfläche von 2 cm unter Verwendung von 6 Träger pro Platte, um die Last gleichmäßig zu verteilen.

SIZE	UP TO 3/4" (2cm)	ABOVE 3/4" (2cm)
FORMATO	FINO A 2 CM	OLTRE AI 2CM
FORMAT	BIS 2 CM	ÜBER 2 CM
24"x24" 60x60 cm (nominal) 4 supports per slab	4 supports (0,32 pcs/sq ft)	please contact your Atlas Concorde sales representative
60x60 cm (nominal) 4 supporti per lastra	4 supporti (0,32 pz/m ²)	contattare il referente commerciale Atlas Concorde
60x60 cm (Nominalstärke) 4 Träger pro Platte	4 Träger (0,32 St/m ²)	bitte kontaktieren sie den handelsvertreter von Atlas Concorde
18"x36" 45x90cm (nominal) 6 supports per slab	6 supports (0,56 pcs/sq ft)	please contact your Atlas Concorde sales representative
45x90 cm (nominal) 6 supporti per lastra	6 supporti (0,56 pz/m ²)	contattare il referente commerciale Atlas Concorde
45x90 cm (Nominalstärke) 6 Träger pro Platte	6 Träger (0,56 St/m ²)	bitte kontaktieren sie den handelsvertreter von Atlas Concorde
24"x36" 60x90cm (nominal) 6 supports per slab	6 supports (0,48 pcs/sq ft)	please contact your Atlas Concorde sales representative
60x90 cm (nominal) 6 supporti per lastra	6 supporti (0,48 pz/m ²)	contattare il referente commerciale Atlas Concorde
60x90 cm (Nominalstärke) 6 Träger pro Platte	6 Träger (0,48 St/m ²)	bitte kontaktieren sie den handelsvertreter von Atlas Concorde
31 1/2"x31 1/2" 80x80 cm (nominal) 4 supports per slab	4 supports (0,2 pcs/sq ft)	please contact your Atlas Concorde sales representative
80x80 cm (nominal) 4 supporti per lastra	4 supporti (0,2 pz/m ²)	contattare il referente commerciale Atlas Concorde
80x80 cm (Nominalstärke) 4 Träger pro Platte	4 Träger (0,2 St/m ²)	bitte kontaktieren sie den handelsvertreter von Atlas Concorde
36"x36" 90x90cm (nominal) 4 supports per slab	4 supports (0,16 pcs/sq ft)	please contact your Atlas Concorde sales representative
90x90 cm (nominal) 4 supporti per lastra	4 supporti (0,16 pz/m ²)	contattare il referente commerciale Atlas Concorde
90x90 cm (Nominalstärke) 4 Träger pro Platte	4 Träger (0,16 St/m ²)	bitte kontaktieren sie den handelsvertreter von Atlas Concorde
12"x48" 30x120cm (nominal) 6 supports per slab	6 supports (0,65 pcs/sq ft)	please contact your Atlas Concorde sales representative
30x120 cm (nominal) 6 supporti per lastra	6 supporti (0,65 pz/m ²)	contattare il referente commerciale Atlas Concorde
30x120 cm (Nominalstärke) 6 Träger pro Platte	6 Träger (0,65 St/m ²)	bitte kontaktieren sie den handelsvertreter von Atlas Concorde
16"x48" 40x120cm (Nominal) 6 supports per slab	6 supports (0,54 pcs/sq ft)	please contact your Atlas Concorde sales representative
40x120 cm (nominal) 6 supporti per lastra	6 supporti (0,54 pz/m ²)	contattare il referente commerciale Atlas Concorde
40x120 cm (Nominalstärke) 6 Träger pro Platte	6 Träger (0,54 St/m ²)	bitte kontaktieren sie den handelsvertreter von Atlas Concorde
24"x48" 60x120cm (Nominal) 6 supports per slab	6 supports (0,32 pcs/sq ft)	please contact your Atlas Concorde sales representative
60x120 cm (nominal) 6 supporti per lastra	6 supporti (0,32 pz/m ²)	contattare il referente commerciale Atlas Concorde
60x120 cm (Nominalstärke) 6 Träger pro Platte	6 Träger (0,32 St/m ²)	bitte kontaktieren sie den handelsvertreter von Atlas Concorde
48"x48" 120x120cm (nominal) 8 supports per slab	8 supports (0,27 pcs/sq ft)	please contact your Atlas Concorde sales representative
120x120 cm (nominal) 8 supporti per lastra	8 supporti (0,27 pz/m ²)	contattare il referente commerciale Atlas Concorde
120x120 cm (nominal) 8 Träger pro Platte	8 Träger (0,27 St/m ²)	bitte kontaktieren sie den handelsvertreter von Atlas Concorde
48"x95" - 120x240cm (Nominal) 15 supports per slab	15 supports (3,4 pcs/sq ft)	please contact your Atlas Concorde sales representative
120x240 cm - (nominal) 15 supporti per lastra	15 supporti (3,4 pz/m ²)	contattare il referente commerciale Atlas Concorde
120x240 cm (Nominalstärke) 15 Träger pro Platte	15 Träger (3,4 St/m ²)	bitte kontaktieren sie den handelsvertreter von Atlas Concorde

INDICATIONS POUR LE MARCHÉ DE L'AMÉRIQUE DU NORD ET OCÉANIE

Format 60x60 cm en 20 mm d'épaisseur

Pour la pose surélevée des dalles au format 60x60 - 20 mm d'épaisseur, nous conseillons une hauteur maximale du plan de plancher de 2 cm.

Format 45x90-60x90-80x80-90x90-30x120-40x120-60x120-120x120-120x240 en 20 mm d'épaisseur

Les formats 45x90, 60x90, 80x80, 90x90, 30x120, 40x120, 60x120, 120x120, 120x240 20 mm d'épaisseur sont adaptés à la pose sur chape, gravier, sable et gazon ou sur des pieds à une hauteur maximale du plancher de 2 cm et en utilisant 6 pieds par dalle de façon à distribuer uniformément la charge.

ESPECIFICACIONES PARA EL MERCADO DE NORTEAMÉRICA Y OCEANÍA

Formato 60x60 cm en 20 mm de espesor

Para la colocación sobreelevada de losas de formato 60x60 - 20 mm de espesor, se recomienda que el plano transitable esté a una altura máxima de - 2 cm.

Formatos 45x90-60x90-80x80-90x90-30x120-40x120-60x120-120x120-120x240 - 20 mm de espesor

Los formatos 45x90, 60x90, 80x80, 90x90, 30x120, 40x120, 60x120, 120x120, 120x240 en 20 mm de espesor son adecuados para ser colocado sobre contrapiso, grava, arena y césped o sobre apoyos a una altura máxima del plano transitable de 2 cm y empleando 6 pedestales por losa en modo de distribuir uniformemente la carga.

РЕКОМЕНДАЦИИ ПО УКЛАДКЕ ПЛИТОК LASTRA 20MM НА ОПОРЫ

формат 60x60 см, толщина 20 мм

При укладке плиток формата 60x60 толщиной 20мм рекомендуется устанавливать их на высоту не более 2 см.

Форматы 45x90-60x90-80x80-90x90-30x120-40x120-60x120-120x120-120x240 см толщиной 20 мм

Форматы 45x90 - 60x90 - 80x80 - 90x90 - 30x120 - 40x120 - 60x120 - 120x120 - 120x240 толщиной 20 мм подходят для укладки на стяжку, гравий или на опоры высотой не более 2 см с использованием опор, как указано в таблице на каждую плитку для равномерного распределения нагрузок.

SIZE	JUSQU'À 2 CM - ¾" AU-DELÀ DE 2 CM - ¾"	
FORMATO	HASTA 2 CM - ¾" MÁS DE 2 CM - ¾"	
ФОРМАТ	ДО 2 CM	БОЛЕЕ 2 CM
60x60 cm (nominal) 4 support par plaque	4 support (0,32 pcs/m ²)	contacter le représentant d'Atlas Concorde
60x60 cm (nominal) 4 pedestales por losa	4 pedestales (0,32 pzas/m ²)	ponerse en contacto con el agente de Atlas Concorde
60x60 cm (номинальный) 4 опоры на каждую плитку	4 опор (0,32 шт./м ²)	обратитесь к представителю Atlas Concorde
45x90 cm (nominal) 6 support par plaque	6 support (0,56 pcs/m ²)	contacter le représentant d'Atlas Concorde
45x90 cm (nominal) 6 pedestales por losa	6 pedestales (0,56 pzas/m ²)	ponerse en contacto con el agente de Atlas Concorde
45x90 cm (номинальный) 6 опор на каждую плитку	6 опор (0,56 шт./м ²)	обратитесь к представителю Atlas Concorde
60x90 cm (Nominal) 6 supports par plaque	6 supports (0,48 pcs/m ²)	contacter le représentant d'Atlas Concorde
60x90 cm (Nominal) 6 pedestales por losa	6 pedestales (0,48 pzas/m ²)	ponerse en contacto con el agente de Atlas Concorde
60x90 cm (номинальный) 6 опор на каждую плитку	6 опор (0,48 шт./м ²)	обратитесь к представителю Atlas Concorde
80x80 cm (nominal) 4 support par plaque	4 support (0,2 pcs/m ²)	contacter le représentant d'Atlas Concorde
80x80 cm (nominal) 4 supporti per lastra	4 pedestales (0,2 pzas/m ²)	ponerse en contacto con el agente de Atlas Concorde
80x80 cm (номинальный) 4 опор на каждую плитку	4 опор (0,2 шт./м ²)	обратитесь к представителю Atlas Concorde
90x90cm (nominal) 4 support par plaque	4 support (0,16 pcs/m ²)	contacter le représentant d'Atlas Concorde
90x90 cm (nominal) 4 pedestales por losa	4 pedestales (0,16 pzas/m ²)	ponerse en contacto con el agente de Atlas Concorde
90x90 cm (номинальный) 4 опор на каждую плитку	4 опор (0,16 шт./м ²)	обратитесь к представителю Atlas Concorde
30x120 cm (nominal) 6 support par plaque	6 support (0,65 pcs/m ²)	contacter le représentant d'Atlas Concorde
30x120 cm (nominal) 6 pedestales por losa	6 pedestales (0,65 pzas/m ²)	ponerse en contacto con el agente de Atlas Concorde
30x120 cm (номинальный) 6 опор на каждую плитку	6 опор (0,65 шт./м ²)	обратитесь к представителю Atlas Concorde
40x120 cm (nominal) 6 support par plaque	6 support (0,42 pcs/m ²)	contacter le représentant d'Atlas Concorde
40x120 cm (nominal) 6 pedestales por losa	6 pedestales (0,42 pzas/m ²)	ponerse en contacto con el agente de Atlas Concorde
40x120 cm (номинальный) 6 опор на каждую плитку	6 опор (0,42 шт./м ²)	обратитесь к представителю Atlas Concorde
60x120 cm (nominal) 6 support par plaque	6 support (0,32 pcs/m ²)	contacter le représentant d'Atlas Concorde
60x120 cm (nominal) 6 pedestales por losa	6 pedestales (0,32 pzas/m ²)	ponerse en contacto con el agente de Atlas Concorde
60x120 cm (номинальный) 6 опор на каждую плитку	6 опор (0,32 шт./м ²)	обратитесь к представителю Atlas Concorde
120x120 cm (nominal) 8 support par plaque	8 support (0,27 pcs/m ²)	contacter le représentant d'Atlas Concorde
120x120 cm (nominal) 8 pedestales por losa	8 pedestales (0,27 pzas/m ²)	ponerse en contacto con el agente de Atlas Concorde
120x120 cm (номинальный) 8 опор на каждую плитку	8 опор (0,27 шт./м ²)	обратитесь к представителю Atlas Concorde
120x240 (nominal) 15 supports par plaque	15 supports (3,4 pcs/m ²)	contacter le représentant d'Atlas Concorde
120x240 cm (nominal) 15 pedestales por losa	15 pedestales (3,4 pzas/m ²)	ponerse en contacto con el agente de Atlas Concorde
120x240 cm (номинальный) 15 опор на каждую плитку	15 опор (3,4 шт./м ²)	обратитесь к представителю Atlas Concorde

RECOMMENDATIONS FOR RAISED INSTALLATION

RACCOMANDAZIONI PER LA POSA SOPRAELEVATA / EMPFEHLUNGEN FÜR DIE VERLEGUNG ALS DOPPELBODEN / CONSEILS POUR LA POSE SURÉLEVÉE / RECOMENDACIONES PARA LA COLOCACIÓN SOBREELEVADA / РЕКОМЕНДАЦИИ ПО УКЛАДКЕ В ВИДЕ ФАЛЬШПОЛА

Tiles requiring the application of a glass fibre double net can be supplied with proper backing by Atlas Concorde. For prices of the application of the reinforcements (steel sheet and double fiberglass mesh) and of the installation accessories (pedestals, spacers, clips, ..) see appendix A "Accessories price list LASTRA 20mm" available on MyAtlas.

Le piastrelle che richiedono l'applicazione di doppia rete in fibra di vetro sono fornite con la necessaria lavorazione da Atlas Concorde. Relativamente ai prezzi dell'applicazione dei rinforzi (foglio di acciaio e doppia rete in fibra di vetro) e degli accessori di posa (supporti, distanziatori, clip, ..) si rimanda all'appendice A: "Listino accessori_LASTRA 20mm" disponibile su MyAtlas.

Fliesen, für die die Anwendung eines doppelten Glasfasernetz notwendig ist, werden mit dieser Bearbeitung durch Atlas Concorde geliefert. Die Preise der verstärkten Ausführungen (Stahlblatt und doppeltes Glasfasernetz) sowie der Verlegeutensilien (Träger, Distanzstücke, Clips..) finden Sie in Anhang A: „Preisliste Zubehör_LASTRA 20 mm“ in MyAtlas.

Les carreaux qui exigent l'application d'un double treillis en fibre de verre sont fournis avec le traitement nécessaire réalisé par Atlas Concorde. L'annexe A (Tarif accessoires_LASTRA 20mm) dans MyAtlas affiche les prix de l'application des renforcements (feuille en acier et double filet en fibre de verre) et des accessoires de pose (supports, entretoises, clips, etc.)

Las baldosas que requieren la aplicación de una red doble de fibra de vidrio son entregadas por Atlas Concorde con la elaboración necesaria. Para los precios de aplicación de los refuerzos (chapa de acero y doble malla de fibra de vidrio) y de los accesorios de instalación (soportes, distanciadores, clips, etc.), véase el Anexo A: "Lista de accesorios_LASTRA 20mm" disponible en MyAtlas.

Плитки, требующие приклеивания двойной стекловолоконной сетки, поставляются с соответствующей обработкой Atlas Concorde. Цены на упрочняющие элементы (стальной лист, двойная стекловолоконная сетка) и на аксессуары (опоры, распорки, кляммеры и т.д.) приведены в приложении А «Грайс-лист на аксессуары_LASTRA 20mm», доступном на MyAtlas.

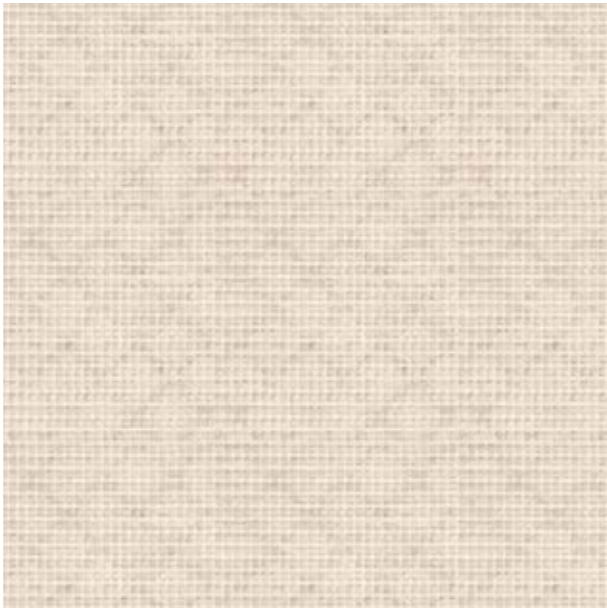

WARNING: OUTDOOR PAVINGS INSTALLED UNGLUED ABOVE THE GROUND LEVEL ARE SUBJECT TO THE ACTION OF THE WIND, WITH THE RISK, IN SOME CASES, OF BECOMING AIRBORNE THE MANUFACTURER RECOMMENDS TO REQUIRE THE ASSISTANCE OF A QUALIFIED PROFESSIONAL IN ORDER TO CHECK THE SUITABILITY OF THE INSTALLATION SYSTEM ABOVE THE GROUND ADOPTED, IN ACCORDANCE WITH THE LOCAL LAWS AND REGULATIONS AND THE CONDITIONS OF USE. FAILURE TO DO SO COULD RESULT IN SERIOUS INJURY OR PROPERTY DAMAGE.

A CERAMIC SLAB INSTALLED ON A RAISED PEDESTAL SYSTEM MAY FRACTURE ON IMPACT IF A HEAVY OBJECT IS DROPPED ONTO IT FROM A HEIGHT, WITH A RISK OF INJURY TO ANYONE STANDING OR WALKING ON SUCH SLAB. FAILURE TO ADHERE TO THE MANUFACTURER'S INSTRUCTIONS FOR INSTALLATION OF SLABS ON RAISED PEDESTAL SYSTEMS MAY RESULT IN SERIOUS INJURY.

For further information and recommendations concerning the installation systems please refer to the outdoor section on the atlas concorde website or to the outdoor catalogue.

ATTENZIONE: LE PAVIMENTAZIONI DA ESTERNO POSATE A SECCO IN QUOTA SONO SOGGETTE ALL'AZIONE DEL VENTO, CON IL RISCHIO DI SOLLEVAMENTO DELLE LASTRE. IL PRODUTTORE RACCOMANDA DI FAR VERIFICARE L'IDONEITÀ DEL SISTEMA DI POSA IN QUOTA DA UN TECNICO ABILITATO IN BASE ALLA NORMATIVA LOCALE VIGENTE ED ALLE CONDIZIONID'USO, AL FINE DI EVITARE IL RISCHIO DI DANNI A PERSONE E COSE.

UNA LASTRA CERAMICA POSATA SU UN SISTEMA SOPRAELEVATO PUÒ ROMPERSI PER IMPATTO QUALORA UN OGGETTO PESANTE CADA SULLA STESSA DA UNA CERTA ALTEZZA, CON IL RISCHIO DI SERI DANNI PER CHIUNQUE POSSA SOSTARE O TRANSITARE SULLA PIASTRELLA STESSA. IL MANCATO RISPETTO DELLE ISTRUZIONI FORNITE DAL PRODUTTORE RELATIVE ALLA POSA SU SISTEMI SOPRAELEVATI PUÒ PROVOCARE SERI DANNI ALLA PERSONE.

Per maggiori informazioni e raccomandazioni di posa si rimanda alla sezione LASTRA 20mm del sito atlas concorde o al catalogo LASTRA 20mm.

WARNUNG: BODENBELÄGE DIE TROCKEN IM AUSSENBEREICH IN DER HÖHE VERLEGT WERDEN, UNTERLIEGEN DER WIRKUNG DES WINDES, WODURCH DIE GEFAHR BESTEHT, DASS DIE PLATTEN AUFGEWORFEN WERDEN. DER HERSTELLER ERTEILT DAHER DIE EMPFEHLUNG, DASS DIE EIGNUNG DES SYSTEMS FÜR EINE VERLEGUNG IN DER HÖHE DURCH EINEN ZUGELASSENEN SACHVERSTÄNDIGEN ÜBERPRÜFT WIRD, WOBEI DIE LOKAL GÜLTIGEN VORSCHRIFTEN UND NUTZUNGSBEDINGUNGEN ZU BEACHTEN SIND, UM DIE GEFAHR VON PERSONEN- UND SACHSCHÄDEN ZU VERMEIDEN.

EINE KERAMIKPLATTE DIE AUF EINEM DOPPELBODENSYSTEM VERLEGT IST, KANN DURCH DEN AUFPRALL EINES AUS EINER BESTIMMTEN HÖHE HERABFALLENDEN GEGENSTANDES ZERBRECHEN. HIER BESTEHT DAS RISIKO SCHWERER VERLETZUNGEN FÜR ALL JENE DIE AUF DER FLIESE GEHEN, ODER STEHEN. BEI NICHTBERÜCKSICHTIGUNG DER VOM HERSTELLER VORGEGBENEN VERLEGEVORSCHRIFTEN FÜR DOPPELBODENSYSTEME, KANN ES ZU SCHWERWIEGENDEN VERLETZUNGEN DER PERSONEN KOMMEN.

Für genauere Informationen und verlegehinweise verweisen wir auf unsere Webseite LASTRA 20mm atlas concorde oder auf unseren katalog LASTRA 20mm.

AVERTISSEMENT : LES DALLAGES EXTÉRIEURS POSÉS SANS COLLAGE SONT SOUMIS À L'ACTION DU VENT, AVEC LE RISQUE DE SOULÈVEMENT DES PLAQUES, NOTAMMENT CEUX POSÉS AUX ÉTAGES D'UN BÂTIMENT. LE FABRICANT RECOMMANDE DE FAIRE VÉRIFIER PAR UN TECHNICIEN QUALIFIÉ LA BONNE ADAPTATION DU SYSTÈME DE POSE EN ÉTAGES AVEC LA RÉGLEMENTATION EN VIGUEUR ET LES CONDITIONS D'UTILISATION LOCALES, AFIN D'ÉVITER LE RISQUE DE DOMMAGES AUX PERSONNES ET AUX BIENS.

UNE DALLE CÉRAMIQUE POSÉE SUR UN SYSTÈME SURÉLEVÉ PEUT SE CASSER À LA SUITE D'UN IMPACT D'UN OBJET LOURD QUI Y CHUTERAIT D'UNE CERTAINE HAUTEUR, AVEC LE RISQUE DE SÉRIEUX DOMMAGES POUR QUICONQUE STATIONNERAIT OU TRANSITERAIT SUR CE CARREAU. LE NON RESPECT DES INSTRUCTIONS FOURNIES PAR LE FABRICANT RELATIVES À LA POSE SUR DES SYSTÈMES SURÉLEVÉS PEUT PROVOCER DES SÉRIEUX DOMMAGES AUX PERSONNES.

Pour toutes informations complémentaires et recommandations de pose, veuillez vous référer à notre site atlas concorde LASTRA 20mm ou à notre catalogue LASTRA 20mm.

ATENCIÓN: LAS PAVIMENTACIONES DE EXTERIORES COLOCADAS EN SECO EN ALTURA ESTÁN SOMETIDAS A LA ACCIÓN DEL VIENTO, CON EL RIESGO DEL LEVANTAMIENTO DE LAS LOSAS. EL PRODUCTOR ACONSEJA HACER VERIFICAR LA IDONEIDAD DEL SISTEMA DE COLOCACIÓN EN ALTURA POR UN TÉCNICO CALIFICADO EN BASE A LA NORMATIVA LOCAL VIGENTE Y A LAS CONDICIONES DE USO, A FIN DE EVITAR EL RIESGO DE DAÑOS A PERSONAS Y COSAS.

UNA LOSA CERÁMICA COLOCADA SOBRE UN SISTEMA ELEVADO PUEDE ROMPERSE PRODUCTO DE UN IMPACTO EN CASO DE QUE UN OBJETO PESADO CAIGA SOBRE ELLA DESDE UNA CIERTA ALTURA, CON EL RIESGO DE SERIOS DAÑOS PARA CUALQUIERA QUE PUEDA DETENERSE O PASAR SOBRE DICHA BALDOSA. NO RESPETAR LAS INSTRUCCIONES ENTREGADAS POR EL FABRICANTE RESPECTO DE LA COLOCACIÓN SOBRE SISTEMAS SOBREELEVADOS PUEDE PROVOCAR SERIOS DAÑOS A LAS PERSONAS.

Para más informaciones y consejos de colocación se aconseja consultar la sección LASTRA 20mm del sitio atlas concorde o el catálogo LASTRA 20mm.

ВНИМАНИЕ: УЛИЧНЫЕ ПОКРЫТИЯ, УЛОЖЕННЫЕ БЕСКЛЕЕВЫМ СПОСОБОМ НА ОПОРЫ, ПОДВЕРЖЕНЫ ВОЗДЕЙСТВИЮ ВЕТРА И, КАК СЛЕДСТВИЕ, РИСКУ ПОДЪЕМА ИЛИ ОТРЫВА ПЛИТОК. ПОЭТОМУ, ВО ИЗБЕЖАНИЕ ТРАВМИРОВАНИЯ ЛЮДЕЙ ИЛИ ПОВРЕЖДЕНИЯ ИМУЩЕСТВА, СИСТЕМА УКЛАДКИ ДЛЯ СООТВЕТСТВУЮЩИХ УСЛОВИЙ ЭКСПЛУАТАЦИИ И ЕЕ СООТВЕТСТВИЕ МЕСТНЫМ НОРМАМ И ПРАВИЛАМ ДОЛЖНЫ БЫТЬ ПРОВЕРЕНЫ КВАЛИФИЦИРОВАННЫМ СПЕЦИАЛИСТОМ.

ПАДЕНИЕ ТЯЖЕЛОГО ПРЕДМЕТА С БОЛЬШОЙ ВЫСОТЫ МОЖЕТ ПОВЛЕЧЬ ЗА СОБОЙ РАЗЛОМ УЛОЖЕННОЙ НА ОПОРЫ ПЛИТКИ С РИСКОМ ПОЛУЧЕНИЯ ТРАВМЫ ДЛЯ ТОГО, КТО НАХОДИТСЯ НА ПЛИТКЕ. НЕСОБЛЮДЕНИЕ ИНСТРУКЦИЙ ПРОИЗВОДИТЕЛЯ ПО УКЛАДКЕ НА ОПОРЫ МОЖЕТ СТАТЬ ПРИЧИНОЙ СЕРЬЕЗНОГО ТРАВМИРОВАНИЯ.

Более подробная информация и рекомендации по укладке доступны в разделе LASTRA 20mm на сайте atlas concorde или в каталоге LASTRA 20mm.

Green Project

Sustainability / Sostenibilità

In the environmental and economic sciences, sustainability is defined as the condition of development capable of ensuring the satisfaction of the needs of the present generation without compromising the ability of future generations to realize their own. Several international certifications guarantee that the Atlas Concorde products meet the criteria of sustainable construction, attesting to their low impact on the ecosystem, compliance with declared standards and attention to comfort.

Nelle scienze ambientali ed economiche, la sostenibilità è definita come condizione di uno sviluppo in grado di assicurare il soddisfacimento dei bisogni della generazione

presente senza compromettere la possibilità delle generazioni future di realizzare i propri. Diverse certificazioni internazionali garantiscono che i prodotti Atlas Concorde rispondono ai criteri del costruire sostenibile, attestandone il basso impatto sull'ecosistema, la conformità agli standard dichiarati e l'attenzione al comfort abitativo.

Certifications / Certificazioni



ISO 9001

In 1995 Atlas Concorde obtained ISO 9001 quality certification for its products. It is an international recognition referring to the company's entire quality system, from the receipt of raw materials to their transformation, from the distribution of the product to their placement on the market.

Sin dal 1995 Atlas Concorde ha ottenuto per i propri prodotti la certificazione di qualità ISO 9001. Si tratta di un riconoscimento internazionale riferito all'intero sistema di qualità aziendale, dall'ingresso delle materie prime alla loro trasformazione, dalla distribuzione del prodotto alla sua immissione sul mercato.

LEED V4*

All Atlas Concorde porcelain floor and white body wall tiles can be used in projects that follow the guidelines of the GREEN BUILDING COUNCIL, which promotes the independent certification system LEED BD&C v4 (Leadership in Energy and Environmental Design, Building Design & Construction), whose parameters establish precise criteria for the design and construction of buildings that are healthy, energy efficient and with low environmental impact. All our products in porcelain stoneware and in white clay can therefore contribute to obtaining the LEED V4 rating of buildings, in relation to different areas: Sustainable Sites, Materials and Resources, Internal Environmental Quality.

Tutti i prodotti in gres porcellanato e in pasta bianca Atlas Concorde possono essere utilizzati in progetti che seguono le linee guida del GREEN BUILDING COUNCIL, che promuove il sistema di certificazione indipendente LEED BD&C v4 (Leadership in Energy and Environmental Design, Building Design & Construction), i cui parametri stabiliscono precisi criteri di progettazione e realizzazione di edifici salubri, energeticamente efficienti e a impatto ambientale contenuto. Tutti i nostri prodotti in gres porcellanato e in pasta bianca possono quindi contribuire all'ottenimento del rating LEED V4 degli edifici, relativamente a diverse aree tematiche: Siti Sostenibili, Materiali e Risorse, Qualità ambientale Interna.

EPD

Atlas Concorde also has an EPD declaration, which attests to the environmental sustainability of its products. The EPD (Environmental Product Declaration) also assesses the life cycle of a product, from extraction to production, transport, installation, maintenance, and cleaning. Atlas Concorde's EPD declaration was certified by the independent certifying body EPD ITALY.

Atlas Concorde dispone inoltre di una dichiarazione EPD, che attesta la sostenibilità ambientale dei prodotti. Anche la EPD (Environmental Product Declaration) valuta il ciclo di vita di un prodotto, dall'estrazione all'utilizzo passando per la produzione, il trasporto, l'installazione, la manutenzione e la pulizia. La dichiarazione EPD di Atlas Concorde è stata certificata dall'ente di certificazione indipendente EPD ITALY.

PEF*

The environmental footprint of products (PEF, Product Environmental Footprint, according to Recommendation 2013/179/EU) is a measurement that, based on various criteria, indicates the environmental performance of a product or service over its lifetime, taking into account supply chain activities: from the extraction of raw materials, to the production, use, and end of life of the product. Atlas Concorde has a verified PEF. Atlas Concorde's PEF was verified by the DNV-GL certifying body.

L'impronta ambientale dei prodotti (PEF, Product Environmental Footprint, secondo la Raccomandazione 2013/179/UE) è una misura che, sulla base di vari criteri, indica le prestazioni ambientali di un prodotto o servizio nel corso del proprio ciclo di vita, tenendo conto delle attività della catena di approvvigionamento: dall'estrazione di materie prime, alla produzione, all'uso e fine vita del prodotto. Atlas Concorde dispone di una PEF verificata. La PEF di Atlas Concorde è verificata dall'organismo di certificazione DNV-GL.

FDES*

Atlas Concorde has also drafted an FDES environmental declaration (Fiche de déclaration environnementale et sanitaire), this also having the purpose of transparently disclosing the product's impact, covering each phase from product extraction to production and finally laying and use.

Atlas Concorde ha realizzato inoltre la dichiarazione ambientale FDES (Fiche de déclaration environnementale et sanitaire), anch'essa con lo scopo di rendicontare in modo trasparente l'impatto del prodotto, a partire dalla fase di estrazione del prodotto, passando dalla fase di produzione, fino alla posa ed all'utilizzo.

HPD

Atlas Concorde has a HPD (Health Product Declaration) declaration, a complete report on the health characteristics of the finished product, compiled according to the HPD standard.

Atlas Concorde dispone della dichiarazione HPD (Health Product Declaration), un report completo sulle caratteristiche di salubrità del prodotto finito, compilato secondo lo standard HPD.

CAM/ISO 14021

An environmental declaration according to the ISO 14021 international standard, observance of Minimum Environmental Criteria, and the adoption of sustainability policies demonstrate Atlas Concorde's attention to environmental issues and allow the inclusion of its products in Green Public Tenders.

La dichiarazione ambientale secondo lo standard internazionale ISO 14021 ed il rispetto dei requisiti dei Criteri Ambientali Minimi permette ad Atlas Concorde, grazie all'adozione di politiche di sostenibilità, di dimostrare l'attenzione alle problematiche ambientali e proporre l'inserimento dei propri prodotti negli Appalti Pubblici Verdi.

For further details, please refer to: Per ulteriori dettagli, fare riferimento a: atlasconcorde.com

PRECAUTIONS FOR CLEANING AND MAINTENANCE

PRECAUZIONI SULLA PULIZIA E MANUTENZIONE

HINWEISE ZUR PFLEGE UND REINIGUNG

PRÉCAUTIONS SUR LE NETTOYAGE ET L'ENTRETIEN

PRECAUCIONES SOBRE LA LIMPIEZA Y MANUTENCIÓN

ЧИСТКА И УХОД



Cleaning and maintenance procedures can be carried out using a common neutral detergent and a direct water jet: the draining power of inclined surfaces and the presence of open joints between slabs encourages the collection of dirt near the discharge points. For large surfaces, it is recommended the use of a washer-dryer and single-brush machines with soft nylon brushes. Please note that a water patina, due to the surface tension feature of liquids, will tend to form on any outdoor surface even when inclined properly. To remove this patina and obtain the complete drying of the floor, it is recommended to push the water towards joints using a scrubbing-brush or to use a wet and dry vacuum cleaner.

Die Reinigung und Pflege kann mit einem normalen Reinigungsmittel und direktem Wasserstrahl durchgeführt werden: die Drainageleistung von geneigten Flächen und das Vorhandensein von Hohlspalten zwischen den Platten leiten den Schmutz dem Abflusssystem zu. Für große Flächen empfiehlt sich der Einsatz von Reinigungsmaschinen und Bürsten mit weichen Nylonborsten. Wir weisen auch darauf hin, dass sich auf jeder Oberfläche für den Außenbereich, auch wenn sie mit einem ausreichenden Gefälle verlegt worden ist, durch die Wirkung der Oberflächenspannung von Flüssigkeiten am Rand der Oberfläche eine dünne Wasserschicht bildet. Um diese zu beseitigen und für die vollständige und korrekte Trocknung des Bodens empfehlen wir das Wasser mit einer Bürste in Richtung Fugen zu schieben oder einen Flüssigkeitssauger zu verwenden.

Las operaciones de limpieza y manutención pueden ser efectuadas con un normal detergente neutro y un chorro directo de agua: las capacidades drenantes de las superficies inclinadas y la presencia de juntas abiertas entre las losas permiten de hecho encauzar la suciedad hacia los puntos de descarga. Para grandes superficies es aconsejable el empleo de máquinas lavadora-secadora y rotativa pulidora con cerdas de nylon suaves. Además hay que tener presente que sobre cualquier superficie para exteriores, si no es colocada con una inclinación oportuna, en el borde la superficie tiende a formarse una ligera patina de agua producto del efecto de tensión superficial de los líquidos. Para eliminar esta película y conseguir el secado completo y correcto del pavimento, se aconseja empujar el agua con una escoba en dirección de las juntas o emplear un aspira líquidos.

Le operazioni di pulizia e manutenzione possono essere eseguite con un normale detergente neutro e un getto diretto di acqua: le capacità drenanti delle superfici in pendenza e la presenza di fughe aperte tra le lastre consentono infatti di convogliare lo sporco verso i punti di scarico. Per grandi superfici è consigliabile l'utilizzo di macchine lavasciuga e monospazzole con setole in nylon morbide. Si tenga inoltre presente che su qualunque superficie per esterni, seppur posata in opportuna pendenza, tende a formarsi sul bordo della superficie una leggera patina di acqua per via dell'effetto di tensione superficiale dei liquidi. Per eliminare questa patina e ottenere l'asciugatura completa e corretta del pavimento, si consiglia di spingere l'acqua con uno spazzolone verso la direzione delle fughe o di utilizzare un aspiraliquidi.

Les opérations de nettoyage et d'entretien peuvent être effectuées avec un détergent neutre normal et un jet d'eau direct : les capacités drainantes des surfaces en pente et la présence de joints ouverts entre les dalles permettent en effet de diriger les saletés vers les points d'évacuation. Pour des grandes surfaces, nous conseillons d'utiliser des aspirateurs nettoyeurs et des monobrosses équipées de brosses en poils nylon souples. Il convient également de noter que sur toute surface pour l'extérieur non convenablement posée en pente, une légère patine d'eau a tendance à se former à cause de l'effet de tension des liquides en surface. Pour éliminer cette patine et obtenir le séchage complet et correct du sol, nous conseillons de pousser l'eau à l'aide d'une brosse à carrelage en direction des joints ou d'utiliser un aspirateur à liquide.

Чистку плиток можно выполнять нейтральным моющим средством и прямой струей воды: дренажные способности наклонной поверхности и наличие открытых швов между плитками обеспечивают отвод грязной воды к стокам. Для больших поверхностей рекомендуется использовать поломочные машины или однодисковые полотеры с мягкими нейлоновыми щетками. Следует иметь в виду, что на наружных покрытиях, уложенных без надлежащего уклона, в силу явления поверхностного натяжения жидкостей может образоваться тонкая водная пленка. Для ее удаления и полного высушивания покрытия рекомендуется согнать воду щеткой-шваброй в сторону швов или использовать водос.

V-SHADE COLOUR-SHADING

STONALIZZAZIONE V-SHADE

DENUANCEMENT, V-SHADE

V-SHADE, MARMORIERUNG

CONTRASTE, V-SHADE

ЦВЕТОВОЕ ОТЛИЧИЕ, V-SHADE



V1

Uniform appearance

Aspetto uniforme

Aspect uniforme

Gleichmäßiges Erscheinungsbild

Aspecto uniforme

Однородный вид



V2

Slight variation

Variatione minima

Variation minimale

Leichte Abweichung

Variación mínima

Минимальная Неоднородность

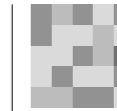

V3

Moderate variation

Variatione moderata

Variation modérée

Mäßige Abweichung

Variación moderada

Умеренная Неоднородность

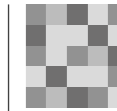

V4

Substantial variation

Variatione sostanziale

Variation substantielle

Grundlegende Abweichung

Variación sustancial

Значительная Неоднородность

The V-Shade classification indicates the colour shading level of a product, that is to say the chromatic and/or surface variation among tiles of the same collection. A strong colour shading is typical of ceramic collections that reproduce natural stones and marble. A moderate colour shading is typical of ceramic collections for which a homogeneous chromatic surface is an aesthetic feature of contemporary design.

La classification VShade indique le niveau de gradation du produit, c'est-à-dire de variation chromatique et/ou superficielle entre des dalles d'une même collection. Une forte variation est conseillée lorsque l'on utilise une collection qui rappelle des matériaux naturels comme la pierre et le marbre. Des variations de tons plus modérées caractérisent des collections où l'homogénéité chromatique superficielle est une qualité esthétique ou véritable indice de design contemporain.

La clasificación V-Shade indica el nivel de variación de tono del producto, o de variación cromática y/o superficial que existe entre las baldosas de una misma colección. Una variación de tono significativa es indicada en las colecciones que evocan materiales naturales como la piedra y el mármol. Variaciones de tono más moderadas caracterizan colecciones en que la homogeneidad cromática superficial es un valor estético índice de un diseño contemporáneo.

La classificazione VShade indica il livello di stonalizzazione del prodotto, ovvero di variazione cromatica e/o superficiale che intercorre tra le piastrelle di una stessa collezione. Una forte stonalizzazione è indicata nelle collezioni che richiamano materiali naturali come la pietra e il marmo. Stonalizzazioni più moderate caratterizzano collezioni in cui l'omogeneità cromatica superficiale è un valore estetico indice di un design contemporaneo.

Die Klassifizierung V-Shade gibt das Niveau des Farbverlaufs des Produktes oder die Abweichung des Farbtons und/oder Oberfläche unter den Fliesen der gleichen Kollektion an. Starke Farbunterschiede zeigen sich vor allem in Kollektionen, die natürliche Materialien wie Stein und Marmor nachempfinden. Weniger starke Farbunterschiede kennzeichnen Kollektionen deren Farbhomogenität der Oberflächen ein ästhetischer Wert des zeitgenössischen Designs darstellen.

Классификация V-Shade указывает на уровень цветовой или фактурной неоднородности плиток, т.е. на отличия по цвету или по фактуре между плитками одной коллекции. Высокая цветовая неоднородность присутствует на плитках, имитирующих природные материалы, например, камень или мрамор. Умеренная неоднородность цвета наблюдается на плитках, предназначенных для оформления интерьеров или экстерьеров в современном стиле.

± 20 mm / ± 30 mm

TECHNICAL FEATURES - CARATTERISTICHE TECNICHE - TECHNISCHE DATEN - CARACTÉRISTIQUES TECHNIQUES - CARACTERÍSTICAS TÉCNICAS - ТЕХНИЧЕСКИЕ ХАРАКТЕРИСТИКИ

Compliant with standards EN 14411 annex G group Bla Conforme alla norma EN 14411 Appendice G gruppo Bla - Compliant with standards ISO 13006 annex G group Bla Conforme alla norma ISO 13006 Appendice G gruppo Bla

Table with columns for Regularity characteristics, Structural characteristics, Bulk mechanical characteristics, Surface mechanical characteristics, Thermal and hygrometric characteristics, Physical properties, Chemical characteristics, and Safety characteristics. It details various technical requirements for nominal size N and specific test methods.

Technical data section including Nominal dimension of size, Manufacturing dimension of size, Weight of slab, Weight of slab per m², and Physical-mechanical features in accordance with EN 1339. It also includes Mechanical features with raised installation in accordance with EN 12825.

Si consiglia la consultazione della pagina: http://webapp.csib.it/upec-ceramique/index.php?view=TitulaireListeProduits&sid=39&tid=1

± 9 mm / ± 9,5 mm

TECHNICAL FEATURES - CARATTERISTICHE TECNICHE - TECHNISCHE DATEN - CARACTÉRISTIQUES TECHNIQUES - CARACTERÍSTICAS TÉCNICAS - ТЕХНИЧЕСКИЕ ХАРАКТЕРИСТИКИ

Compliant with standards EN 14411 annex G group Bla Conforme alla norma EN 14411 Appendice G gruppo Bla - Compliant with standards ISO 13006 annex G group Bla Conforme alla norma ISO 13006 Appendice G gruppo Bla

Table with columns for Regularity characteristics, Structural characteristics, Bulk mechanical characteristics, Surface mechanical characteristics, Thermal and hygrometric characteristics, Physical properties, Chemical characteristics, and Safety characteristics. It details various technical requirements for nominal size N and specific test methods, including GRIP and TEXTURED options.

(*) Anti-slip performance is guaranteed at the time of delivery of the product. Le prestazioni anti-slip vengono garantite al momento della consegna del prodotto.
(**) The permissible deviation, in % or mm, of the average size for each tile (2 or 4 sides) from work size (W). Deviazione ammissibile, in % oppure mm, della dimensione media di ogni piastrella (2 oppure 4 lati) dalla dimensione di fabbricazione (W).

PACKAGING

IMBALLI
VERPACKUNG
PACKAGING ET EMBALLAGES
PACKAGING Y EMBALAJES
УПАКОВКА

	Pieces x box Pezzi x scatola Stück pro Karton Pièces par boîte Piezas por caja Штук в коробке	M ² x box M ² x scatola M ² pro Karton M ² par boîte M ² por caja Кв.м в коробке	Boxes x pallet Scatole x pallet Kartons pro Palette Boîtes par palette Cajas por pallet Коробок на поддоне	Kg x box Kg x scatola Kg pro Karton Kg par boîte Kg por caja кг в коробке	M ² x pallet M ² x pallet M ² pro Palette M ² par palette M ² por pallet Кв.м на поддоне
± 20 mm					
22,5x45,4	5	0,51	40	20,43	20,40
22,5x22,5	11	0,56	40	22,72	22,24
30x60	3	0,54	40	24,00	21,60
60x60	2	0,72	30	33,00	21,60
45x90	2	0,81	27	37,00	21,87
60x90	2	1,08	18	48,50	19,44
30x120	2	0,72	36	33,00	25,92
60x120	1	0,72	35	33,35	25,20
90x90	1	0,81	18	37,60	14,58
120x120	1	1,44	20	67,66	28,80
120x240	1	2,88	9	134,00	25,92
± 30 mm					
60x60	2	0,72	30	33,00	21,60
± 9 mm / ± 9,5 mm					
22,5x45,3	12	1,22	34	23,70	41,59
22,5x22,5	20	1,01	42	19,40	42,53
30x60	7	1,26	40	24,85	50,40
60x60	3	1,08	40	21,57	43,20
15x90	10	1,35	36	26,67	48,60
22,5x90	6	1,22	36	25,20	43,74
37,5x75	4	1,13	48	23,68	54,00
20x120	6	1,44	42	31,10	60,48
18,5x150	4	1,11	40	23,68	44,40
120x120	2	2,88	20	58,00	57,60
± 8 mm					
30x30	13	1,17	48	20,28	56,16
30x60	8	1,44	40	26,00	57,60
± 8,6 mm					
15x30	28	1,26	44	22,80	55,44



MADE IN ITALY. MADE TO EXCEL.

MADE IN ITALY

The Made in Italy logo of Atlas Concorde stands for style, quality and ethics. Having firmly adhered to the Ethical Code promoted by Confindustria Ceramica, Atlas Concorde places the Made in Italy logo on all the products designed and produced in Italy, that is to say ceramic tiles, decorations and the majority of special trim tiles. Only a small amount of the latter is manufactured in Spain. Atlas Concorde products are produced using eco-friendly technologies, top quality and safe raw materials with the best working conditions guaranteed for our personnel. For these reasons, Atlas Concorde's Made in Italy is the expression of strong values such as style, design, product quality, and respect for the environment and the people who live in it.

Il marchio Made in Italy di Atlas Concorde è sinonimo di stile, qualità ed etica. Avendo aderito con convinzione al Codice Etico di Confindustria Ceramica, Atlas Concorde appone il marchio Made in Italy su tutti i prodotti studiati, progettati e realizzati in Italia, nella fattispecie tutte le piastrelle di ceramica, le decorazioni e la maggioranza dei pezzi speciali. Solo un ristretto numero di questi ultimi è fabbricato in Spagna. I prodotti Atlas Concorde sono inoltre realizzati con tecnologie rispettose dell'ambiente, utilizzando materie prime eccellenti e sicure, garantendo le migliori condizioni di lavoro. Per queste ragioni il Made in Italy di Atlas Concorde è espressione di valori forti quali stile, design, qualità del prodotto, attenzione all'ambiente e alle persone.



The Ceramics of Italy logo is an exclusive identification on ceramic products which have effectively been made in Italy by companies that are a part of the Confindustria Ceramica and who adhered to its Ethical Code. This Code, promoted and created by Confindustria Ceramica, commits all companies to communicate, clearly and with transparency, the origin of their products.

Il marchio Ceramics of Italy contrassegna esclusivamente i prodotti ceramici effettivamente realizzati in Italia da un'azienda associata a Confindustria Ceramica che ha sottoscritto il Codice Etico. Il Codice, redatto dalla stessa Confindustria Ceramica, impegna a comunicare con chiarezza l'origine dei prodotti.

www.ceramica.info



Ceramiche Atlas Concorde S.p.A.
Via Canaletto 141
41042 Spezzano di Fiorano (MO) - Italia

Atlas Concorde USA, Inc.
117 Seaboard Lane - Suite F170
Franklin, TN 37067 - USA

Atlas Concorde Russia
Business centre "Meliora Place"
Prospekt Mira 6
129090 Moscow - Russia

atlasconcorde.com